

Ductless Split Single Zone Outdoor Unit R-32, R-454B Refrigerant

Models

115 VOLT	FHSR09B1C, FHSR12B1C
208/230 VOLT	FHSR18B3D, FHSR24B3D,
115 VOLT	FPHSR09A1C, FPHSR12A1C
208/230 VOLT	FPHSR09A3D, FPHSR12A3D, FPHSR18A3D, FPHSR24A3D, FSHSR36B3D



RECOGNIZE THIS SYMBOL AS AN INDICATION OF IMPORTANT SAFETY INFORMATION!

▲ WARNING

THESE INSTRUCTIONS ARE INTENDED AS AN AID TO QUALIFIED SERVICE PERSONNEL FOR PROPER INSTALLATION, ADJUSTMENT AND OPERATION OF THIS UNIT. READ THESE INSTRUCTIONS THOROUGHLY BEFORE ATTEMPTING INSTALLATION OR OPERATION. FAILURE TO FOLLOW THESE INSTRUCTIONS MAY RESULT IN IMPROPER INSTALLATION, ADJUSTMENT, SERVICE OR MAINTENANCE, POSSIBLY RESULTING IN FIRE, ELECTRICAL SHOCK, CARBON MONOXIDE POISONING, EXPLOSION, PROPERTY DAMAGE, PERSONAL INJURY OR DEATH.

▲ WARNING

PROPOSITION 65 WARNING: THIS PRODUCT CONTAINS CHEMICALS KNOWN TO THE STATE OF CALIFORNIA TO CAUSE CANCER, BIRTH DEFECTS OR OTHER REPRODUCTIVE HARM.

DO NOT DESTROY THIS MANUAL. PLEASE READ CAREFULLY AND KEEP IN A SAFE PLACE FOR FUTURE REFERENCE BY A SERVICEMAN.

For outdoor unit only, refer to the indoor unit Installation and Operation Manual as well as the Remote Control Operation instructions for additional information.



Register your Air Conditioner

Model information can be found on the name plate. Please complete and mail the owner registration card furnished with this product, or register online at www.friedrich.com.



A. IMPORTANT SAFETY AND GENERAL INFORMATION 3

 A.1 Introduction 3

 A.2 · Safety Symbols 3

 A.4 Importance of a Quality Installation..... 5

 C.1 Tools..... 6

 C.2 Clearances 7

 C.3 Pre-Installation Checkpoints..... 8

 C.4 Install Condensate Drain 9

 C.5 Install Ground Pad or Wall Hangers 9

 C.6 Piping Connections to Outdoor Unit..... 9

E. ELECTRICAL..... 10

 E.1 Specifications..... 10

 E.2 Wiring Diagrams 11

G. LEAK CHECK, CHARGING AND TRIPLE EVACUATION..... 12

J. STARTUP AND OPERATION..... 14

 J.1 Checklist and Operation Test..... 14

ESPAÑOL..... 16

FRANÇAIS 31

Operating condition

The protective device maybe trip and stop the appliance in the cases listed below.

HEATING	Outdoor air temperature is over 75°F(24°C)
	Outdoor air temperature is below -4°F(-20°C)
	Room temperature is over 80.6°F(27°C)
COOLING	Outdoor air temperature is over *115°F(46°C)
	Room temperature is below 70°F(21°C)
DRY	Room temperature is below 64.5°F(18°C)

**For Tropical (T3) Climate condition models, the temperature point is 131°F(55°C) instead of 109°F(43°C). The temperature of some products is allowed beyond the range. In specific situation, please consult the merchant.*

**For R32 refrigerant models can keep heating at -4°F(-20 °C) outdoor ambient , for R454B efrigerant models can keep heating at -13°F(-25 °C) outdoor ambient. For some models, can keep heating even at lower outdoor ambient*

If the air conditioner runs in COOLING or DRY mode with door or window opened for a long time when relative humidity is above 80%,dew may drip down from the outlet.

A. IMPORTANT SAFETY AND GENERAL INFORMATION

A.1 Introduction

This booklet contains the installation and operating instructions for your Air Conditioning unit. There are some precautions that should be taken to ensure proper operation. Improper installation can result in unsatisfactory operation or dangerous conditions.

Read this booklet and any instructions packaged with separate equipment required to make up the system prior to installation. Give this booklet to the owner and explain its provisions. The owner should retain this booklet for future reference.

A.2 · Safety Symbols

SAFETY IS IMPORTANT

We have provided many important safety messages in this manual and on your appliance. Always read and obey all safety messages.



This is a safety Alert symbol. This symbol alerts you to potential hazards that can kill or hurt you and others.

All safety messages will tell you what the potential hazard is, tell you how to reduce the chance of injury, and tell you what will happen if the instructions are not followed.

All safety messages will follow the safety alert symbol with the word "WARNING" or "CAUTION". These words mean:



WARNING Indicates a hazard which, if not avoided, can result in severe personal injury or death and damage to product or other property.



CAUTION Indicates a hazard which, if not avoided, can result in personal injury and damage to product or other property.

NOTICE

Indicates property damage can occur if instructions are not followed.



This symbol indicates that this appliance uses a flammable refrigerant. If the refrigerant is leaked and is exposed to an external ignition source, there is a risk of fire.



This symbol indicates that the Operation Manual should be read carefully.



This symbol indicates that service personnel should be handling this equipment with reference to the installation manual.



This symbol indicates that information is available such as the Installation and Operation manual, or the Service Manual.

A. IMPORTANT SAFETY AND GENERAL INFORMATION

A.3 · Safety Warnings

⚠️ WARNING: The manufacturer's warranty does not cover any damage or defect to the air conditioner caused by the attachment or use of any components, accessories or devices (other than those authorized by the manufacturer) into, onto or in conjunction with the air conditioner. You should be aware that the use of unauthorized components, accessories or devices may adversely affect the operation of the air conditioner and may also endanger life and property. The manufacturer disclaims any responsibility for such loss or injury resulting from the use of such unauthorized components, accessories or devices.

⚠️ WARNING: This appliance is not intended for use by persons (Including children) with reduced physical, sensory or mental capabilities, or lack of experience and knowledge, unless they have been given supervision or instruction concerning use of the appliance by a person responsible for their safety.

Children should be supervised to ensure that they do not play with the appliance.

⚠️ WARNING: The maximum altitude for this appliance is 2,000 meters(6,562 feet).

Do not use above 2,000 meters(6,562 feet).

⚠️ WARNING: Electrical Shock Hazard

Disconnect all power to the unit before starting maintenance. All electrical connections and wiring **MUST** be installed by a qualified electrician and conform to all local codes which have jurisdiction. Failure to do so can result in property damage, severe electrical shock or death.



⚠️ WARNING: Read Installation Manual

Read this manual thoroughly prior to equipment installation or operation. It is the installer's responsibility to properly apply and install the equipment. Installation must be in conformance with the NFPA 70-2023 national electric code or current edition, International Mechanic code 2021 or current edition, and any other local or national codes.



⚠️ WARNING: Safety First

Do not remove, disable, or bypass this unit's safety devices. Doing so may cause fire, injuries, or death.

⚠️ WARNING: This Product uses R-32 or R-454B Refrigerant

Do not use means to accelerate the defrosting process or to clean, other than those recommended by the manufacturer.

The appliance shall be stored in a room without continuously operating ignition sources (for example: open flames, an operating gas appliance or an operating electric heater.

Do not pierce or burn.

Be aware that refrigerants may not contain an odor.



⚠️ WARNING: Refrigeration System under High pressure

Do not puncture, heat, expose to flame or incinerate. Only certified refrigeration technicians should service this equipment. R454B systems operate at higher pressures than R22 equipment. Appropriate safe service and handling practices must be used.

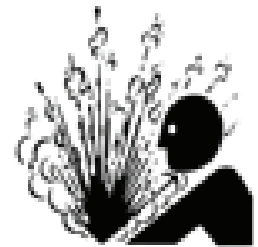

⚠️ CAUTION: Do Not Operate Equipment During Active Stages Of Construction

To ensure proper operation, Friedrich requires that all equipment is not operated during active construction phases. This includes active stages of completing framing, drywalling, spackling, sanding, painting, flooring, and moulding in the equipment's designated conditioning space. The use of this equipment during construction could result in premature failure of the components and/or system and is in violation of our standard warranty guidelines. The operation of newly installed equipment during construction will accelerate the commencement and/or termination of the warranty period.

⚠️ WARNING: Keep all air circulation and ventilation openings free from obstruction.

⚠️ WARNING: The unit should not be in contact with any equipment that will transmit vibration to the unit. Any excessive vibration or pulsation to the unit could result in damage to the refrigerant tubing.

A. IMPORTANT SAFETY AND GENERAL INFORMATION

A.4 Importance of a Quality Installation

Optimal system performance and longevity depend upon a quality and proper installation. Failure to properly install this unit could result in undesirable operation and subsequent faults and potential failures.

Carefully follow all guidelines listed in the manual and industry best practices. Conform to all local code requirements. Contact your local technical representative with any questions or concerns.

Due to continuing research in new energy-saving technology, all information in this manual is subject to change without notice.

Upon receiving the unit, inspect it for any damage from shipment. Claims for damage, either shipping or concealed, should be filed immediately with the shipping company. **IMPORTANT:** Check the unit model number, Cooling size, electrical characteristics, and accessories to determine if they are correct.

⚠ WARNING: Check the unit power cord and make sure the cord is protected from wear, corrosion, excessive pressure, vibration, sharp edges, or any other adverse environmental effects. It is recommended that the cord is checked for any potential damage when filter maintenance is performed. If the supply cord is damaged, it must be replaced by the manufacturer, its service agent or similarly qualified persons in order to avoid a hazard.

⚠ WARNING: If the unit appears damaged, or if a refrigerant leak is suspected, do not install. Contact a licensed repair person to perform a leak check on the unit.



⚠ WARNING: Under no circumstances shall potential sources of ignition be used in the searching for or detection of refrigerant leaks. A halide torch (or any other detector using a naked flame) shall not be used. The following leak detection methods are deemed acceptable for all refrigerant systems. Electronic leak detectors may be used to detect refrigerant leaks but, in the case of **FLAMMABLE REFRIGERANTS**, the sensitivity may not be adequate, or may need re-calibration. (Detection equipment shall be calibrated in a refrigerant-free area.) Ensure that the detector is not a potential source of ignition and is suitable for the refrigerant used. Leak detection equipment shall be set at a percentage of the LFL.

⚠ WARNING: Service of this product (aside from filter maintenance) shall only be performed by trained service personnel. This includes:

- Opening of any ventilated Any tubing or refrigerant circuit work.
- Opening of any sealed components.
- Enclosures beyond the hinged door for filter cleaning.
- Disposal or decommissioning of the unit.

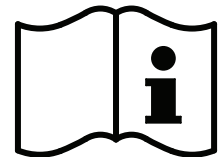

C. INSTALLATION OF THE UNIT

C.1 Tools

Verify with tool manufacturers that all tools used during servicing of the refrigerant are non-sparking and can be used with A2L Refrigerants. No halide torches for leak testing.

Refrigerant monitors or detectors must be used to detect refrigerant in the work area.

- R-32 A2L Refrigerant Recovery System.
- Vacuum Pump rated for A2L refrigerant (capable of 300 microns or less vacuum.)
- Nitrogen bottle with purging and pressurizing capabilities up to 550 psi.
- Non-Sparking (Not Halide) Electronic Leak Detector rated for detecting A2L refrigerant.
- Digital refrigerant scale Refrigeration Gauges rated for A2L Refrigerants with temp scales for R-32 refrigerant.
- Gauge Manifold (Right handed threads).
- A2L compatible Vacuum Gauge capable of 300 microns or less.
- Nitrogen regulator for purging and testing, rated to 800 psi. (Capable of low psi flow)
- Pipe tubing cutter.
- Refrigerant recovery cylinder. (Flammable A2L label)
- Ventilation fan.
- Class ABC fire extinguisher.
- Purge hose fittings
- Flaring tool



ABC Fire Extinguisher



Recovery Machine



Vacuum Pump



Nitrogen



Gauge Manifold



Nitrogen Regulator



Vacuum Gauge

Figure C.1 (Tools)

C. INSTALLATION OF THE UNIT

C.2 Clearances

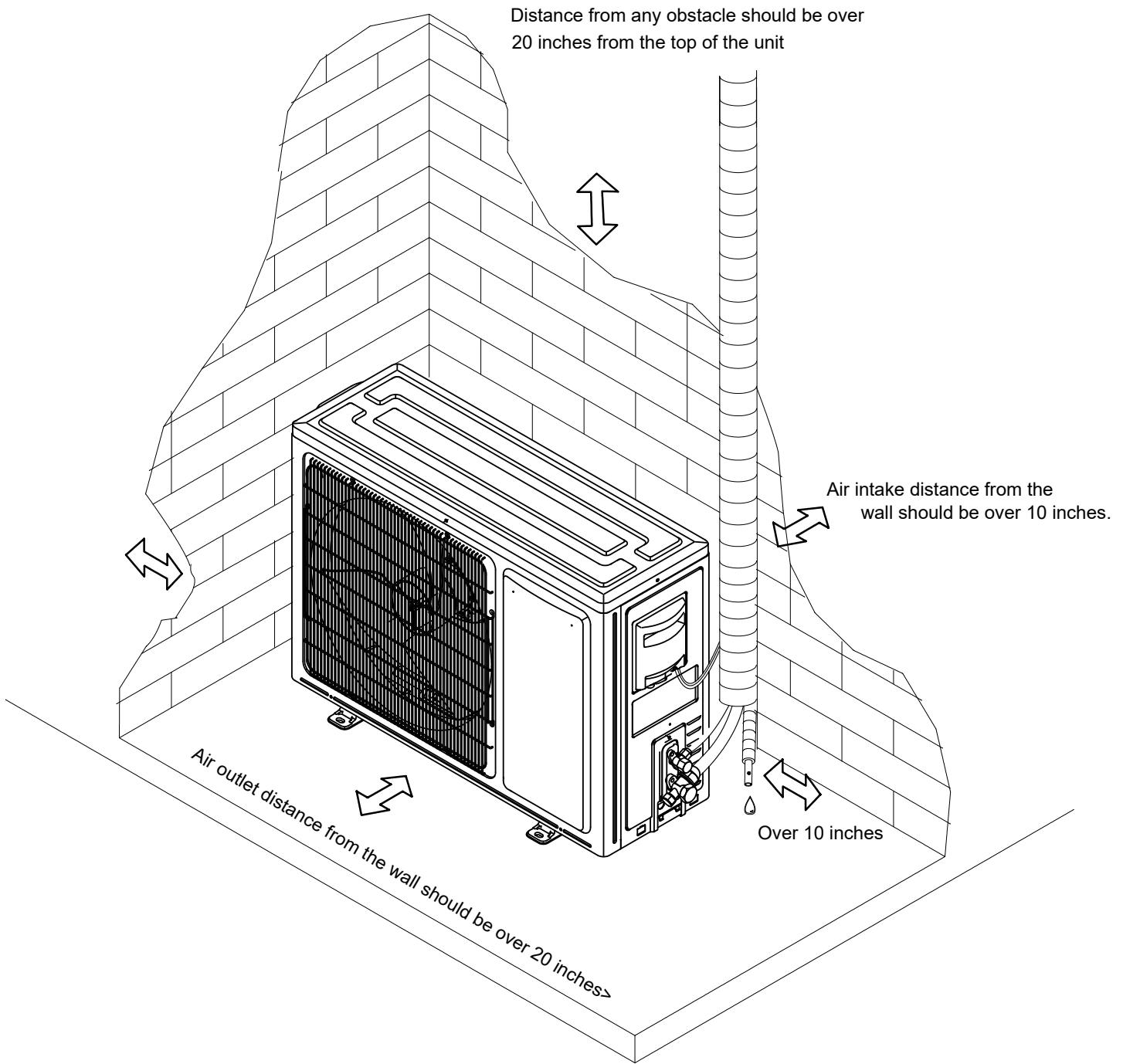

Figure C.2

C. INSTALLATION OF THE UNIT

C.3 Pre-Installation Checkpoints

- Location is convenient to install and well ventilated.
- Avoid installing it where flammable gas could leak.
- Keep the required distance from walls and other obstacles.
- Keep the outdoor unit away from grease and debris.
- Avoid installing it by the roadside where there is a risk of muddy water.
- Install on a fixed base where it is not subject to increased operation noise.
- Ensure there is no blockage of the air outlet.
- Avoid installing under direct sunlight, in an aisle or sideway, or near heat sources and ventilation fans.
- Keep away from flammable materials, thick oil fog, and wet or uneven places.
- Outdoor unit comes pre-charged with refrigerant for 25 ft of line set.
- If the indoor unit is installed more than 16 ft in elevation below the outdoor unit, an oil trap should be installed every 16 ft in elevation drop.

NOTE:

1. To avoid storing too much oil in the oil bend, the oil bend should be as short as possible.
2. The horizontal piping should be sloped down along the refrigerant flow direction, to bring the oil back to compressor. The slope should be between 1/200 and 1/250.

- Indoor unit can not be installed more than 50 feet in elevation above the outdoor unit.
- Refer to refrigerant Leak Check, Charging, and Evacuation section of the manual.

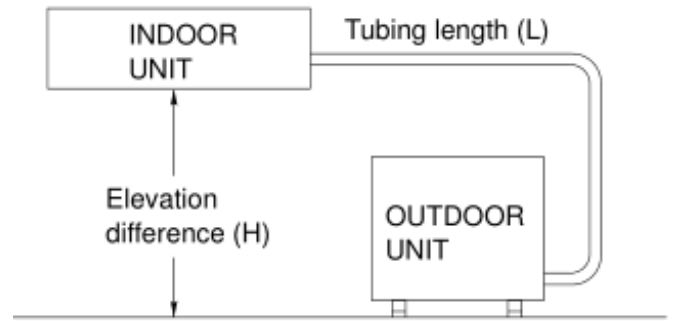
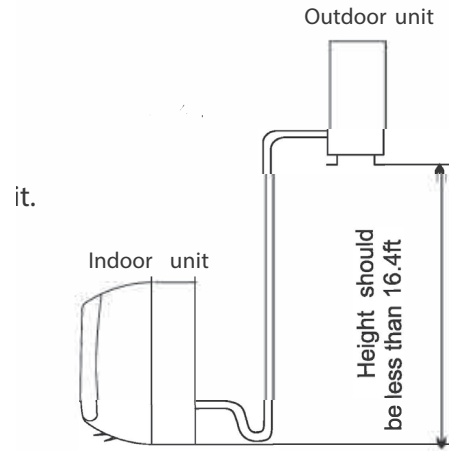

Figure C.3.1



Outdoor unit is higher than indoor unit

Figure C.3.2

Model	Refrigerant Pre-Charge	Pipe Size		Standard Length (ft)	Max. Elevation H (ft)	Max. Length L (ft)	Additional Refrigerant (oz/ft)
		LIQUID	GAS				
FPHSR09A1C	33.5 oz	1/4"	3/8"	25	50	66	.22
FPHSR09A3D	35.2 oz	1/4"	3/8"	25	50	66	.22
FSHSR09B1C	21.2 oz	1/4"	3/8"	25	50	66	.22
FPHSR12A1C	35.3 oz	1/4"	3/8"	25	50	66	.22
FPHSR12A3D	38.1 oz	1/4"	3/8"	25	50	66	.22
FSHSR12B1C	21.9 oz	1/4"	3/8"	25	50	66	.22
FPHSR18A3D	53 oz	1/4"	1/2"	25	50	100	.22
FSHSR18B3D	45.9 oz	1/4"	1/2"	25	50	100	.22
FPHSR24A3D	70.6	3/8"	5/8"	25	50	100	.32
FSHSR24B3D	47.6	3/8"	5/8"	25	50	100	.32
FSHSR36B3D	72.4	3/8"	5/8"	25	50	100	.43

Table C.3.3

⚠ WARNING



Fire Hazard

A2L refrigerant is classified as mildly flammable. Temperatures on surfaces that may be exposed to leakage of FLAMMABLE REFRIGERANTS shall not exceed 1292°F

⚠ WARNING



Refrigeration System Under High Pressure

Do not puncture, heat, expose to flame or incinerate. Only certified refrigeration technicians should service this equipment. R-32 and R-454B systems operate at higher pressures than R22 equipment. Appropriate safe service and handling practices must be used. Only use gauge sets designed for use with R32 and R-454B. Do not use standard R22 gauge sets..

C. INSTALLATION OF THE UNIT

C.4 Install Condensate Drain

Install Condensate Drain for Outdoor Unit

The condensate drains from the outdoor unit when the unit operates in heating mode.

Install a drain port and a drain hose to direct the condensate water. Just install the drain port and rubber washer to the chassis of the outdoor unit, then connect a drain hose to the port. See Figure C.3

Figure C.4

Place under the leg pedestal

Rubber pad (optional)

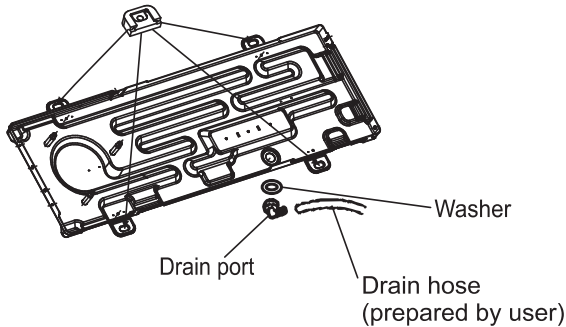

C.6 Piping Connections to Outdoor Unit

1. Remove service valve cover(if provided) to access the service valves and refrigerant ports.
2. Carefully bend and adjust length of refrigerant pipes to meet outdoor unit service valves connection with proper tools to avoid kinks.
3. Apply a small amount of refrigerant oil to the flare connection on the refrigerant pipe.
4. Properly align piping and tighten flare nut using a standard wrench and a torque wrench as shown in the indoor piping section.
5. Carefully tighten flare nuts to correct torque level referring to the following Torque Table:

"Pipe diameter /inch"	"Nut Size /inch"	Tightening Torque	
		ft-lbs	N-m
1/4	1/4	11 to 15	15 to 20
3/8	3/8	22 to 26	30 to 35
1/2	1/2	37 to 41	50 to 55
5/8	5/8	44 to 48	60 to 65
3/4	3/4	52 to 55	70 to 75

Caution: Over tightening may damage flare connections and cause leaks.

Table C.6

C.5 Install Ground Pad or Wall Hangers

1. Refer to section C.1 and Section C.2 to identify proper unit location.
2. Follow all instructions provided by manufacturer for installing wall hangers rubber pad .
3. Verify the wall hangers or rubber pad can safely support the weight of the outdoor unit.
4. Verify the wall hangers or rubber pad is level and meets all outdoor dimensional clearance.
5. Attach with bolts and nuts tightly on a flat and strong floor. If installed on the wall or roof, make sure to attach the support well to prevent it from shaking due to serious vibration or strong wind .

⚠ WARNING

Florida wind load requirements state that outdoor unit must be anchored to concrete pad using four 3/8-in diameter power wedge bolt plus(or equivalent) with 1-in diameter fender washers. Anchor bolts must be embedded into 3000 PSI minimum concrete at a distance of 4 1/2- in from any concrete edge. The concrete thickness must exceed 1.5 times the anchor depth.

E. ELECTRICAL

E.1 Specifications

Model	Wire Diameter(AWG) Interconnecting Wire between Indoor and Outdoor Unit	Main Power Supply To Outdoor Unit		
		Wire Size	MOP (Rating of Over current Device)	MCA (Minimum Circuit Ampacity)
FPHSR09A1C	14-4 AWG 600V THHN	Size according to Local and National Electrical codes.	25A	16A
FPHSR09A3D	14-4 AWG 600V THHN		15A	9.5A
FSHSR09B1C	14-4 AWG 600V THHN		25A	14.6A
FPHSR12A1C	14-4 AWG 600V THHN		25A	16A
FPHSR12A3D	14-4 AWG 600V THHN		15A	10.5A
FSHSR12B1C	14-4 AWG 600V THHN		25A	15.4
FPHSR18A3D	14-4 AWG 600V THHN		30A	20A
FSHSR18B3D	14-4 AWG 600V THHN		20A	14.5A
FPHSR24A3D	14-4 AWG 600V THHN		35A	22A
FSHSR24B3D	14-4 AWG 600V THHN		35A	21A
FSHSR36B3D	14-4 AWG 600V THHN		40A	25.8A

Table E.1

Indoor Unit

Connect the power cord to the indoor unit by connecting the wires to the terminals on the control board individually in accordance with the outdoor unit connection.

Note: For some models, it is necessary to remove the cabinet to connect to the indoor unit terminal.

Outdoor Unit

1. Remove the cable cross board from the unit by loosening the screw. Connect the wires to the terminals on the control board individually per circuit diagram posted on inside of access door. Refer to Figure E.2.
2. Secure the power cord onto the control board with cable clamp.
3. Reinstall the cable cross board to the original position with the screw.
4. Use a recognized circuit breaker between the power source and the unit. (Refer to Table E.1. An electrical disconnect must be installed according to local and national codes. Refer to Table E.1.

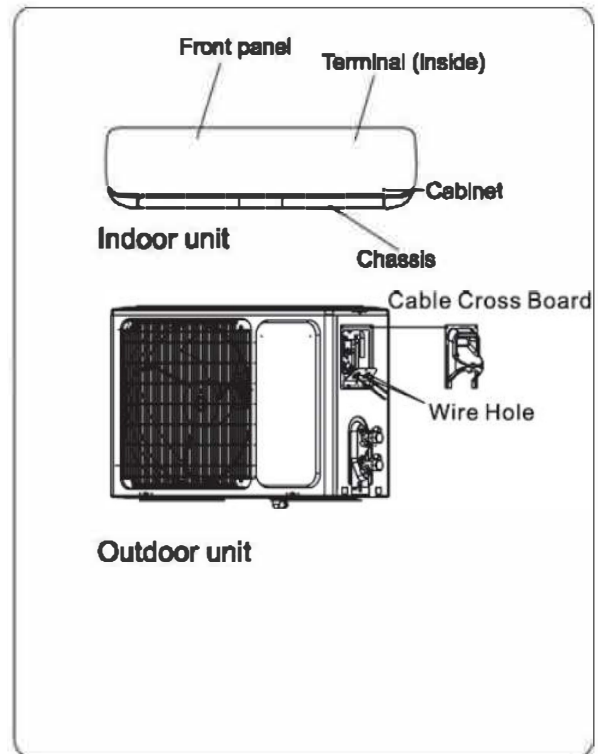

Figure E.2

WIRE SIZE	Use ONLY wiring size recommended by the National Electric Code (NEC) for single outlet branch circuit.
FUSE/CIRCUIT BREAKER	Use ONLY type and size fuse or HACR circuit breaker indicated on unit's rating plate. Proper current protection to the unit is the responsibility of the owner.
GROUNDING	Unit MUST be grounded from branch circuit to unit, or through separate ground wire. Be sure that branch circuit or general purpose outlet is grounded. Do NOT use an extension cord.
ELECTRICAL DISCONNECT	Ensure an electrical disconnect is installed according local and national electrical codes

E.2 Wiring Diagrams

Make sure that the color of the wires in the outdoor unit and terminal No. are the same as those of the indoor unit.

1) 208/230V

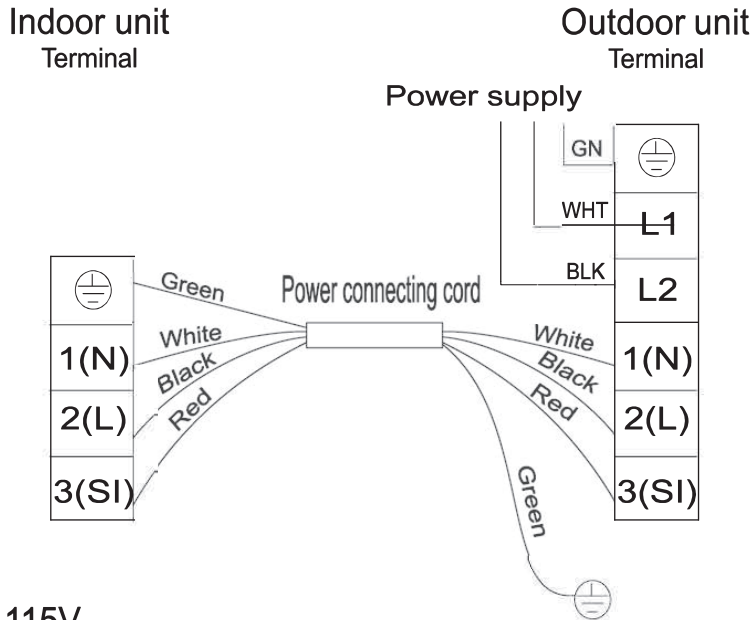

2) 115V

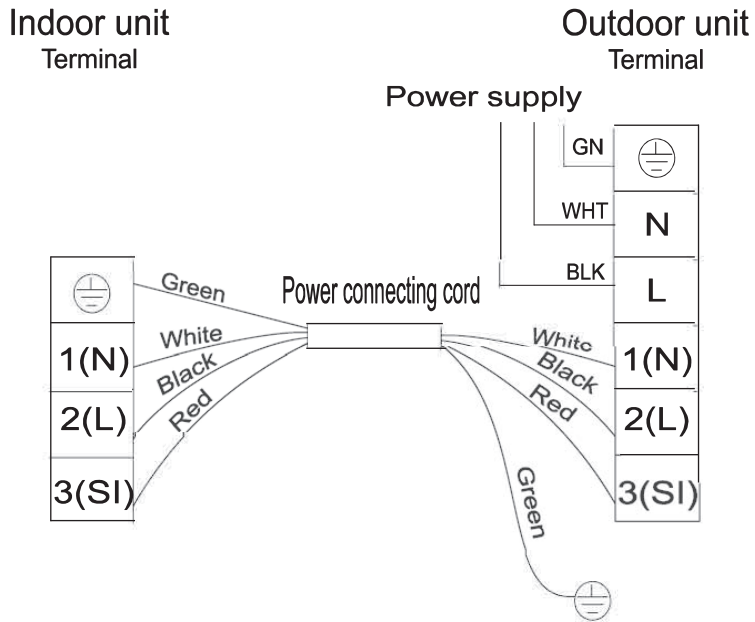

☑ Diagram is reference only, actual product terminals should be followed.

G. LEAK CHECK, CHARGING AND TRIPLE EVACUATION

Warning:

No ignition sources: No person carrying out work in relation to a REFRIGERATING SYSTEM which involves exposing any pipe work shall use any sources of ignition in such a manner that it may lead to the risk of fire or explosion. All possible ignition sources, including cigarette smoking, should be kept sufficiently far away from the site of installation, repairing, removing and disposal, during which refrigerant can possibly be released to the surrounding space. Prior to work taking place, the area around the equipment is to be surveyed to make sure that there are no flammable hazards or ignition risks.

Ventilated Area: Ensure that the area is in the open or that it is adequately ventilated before accessing the refrigerant in the system or conducting any hot work. A degree of ventilation shall continue during the period that the work is carried out. The ventilation should safely disperse any released refrigerant away from the work area or external to building envelope.

During Repairs To Sealed Components: All power must be removed from the equipment being worked on prior to any removal of sealed covers, etc. If it is absolutely necessary to have an electrical supply to equipment during servicing, then a constant leak detector shall be located at the most critical point to warn of a potentially hazardous situation.

Checks And Repairs To Electrical Devices:

- Repair and maintenance to electrical components shall include initial safety checks and component inspection procedures. If a fault exists that could compromise safety, then no electrical supply shall be connected to the circuit until it is satisfactorily dealt with. If the fault cannot be corrected remove power supply to unit. **DO NOT OPERATE.**
- Initial safety checks shall include:
 - That capacitors are discharged: this shall be done in a safe manner to avoid possibility of sparking;
 - That no live electrical components and wiring are exposed while charging, recovering or purging the system;
 - Verify unit is properly grounded.
- Particular attention shall be paid to the following to ensure that by working on electrical components, the casing is not altered in such a way that the level of protection is affected. This shall include damage to cables, excessive number of connections, terminals not made to original specification, damage to seals, incorrect fitting of glands, etc.
- Ensure that the apparatus is mounted securely.
- Ensure that seals or sealing materials have not degraded to the point that they no longer serve the purpose of preventing the ingress of flammable atmospheres. Replacement parts shall be in accordance with the manufacturer's specifications.

The following is a list of important considerations when working with R-32 or R-454B equipment:

- R-32 or R-454B pressure is similar to R-410A and approximately 60% higher than R-22 pressure.
- R-32 or R-454B cylinders must not be allowed to exceed 125°F, they may leak or rupture.
- R-32 or R-454B must never be pressurized with a mixture of compressed air, it may become MORE flammable.
- Servicing equipment and components must be specifically designed for use with R-32 or R-454B and dedicated to prevent contamination.
- Manifold sets must be equipped with gauges capable of reading 750 psig (high side) and 200 psig (low side), with a 500-psig low-side retard.
- Gauge hoses must have a minimum 750-psig service pressure rating.

- Recovery cylinders must have a minimum service pressure rating of 400 psig, (DOT 4BA400 and DOT BW400 approved cylinders).
- POE (Polyol-Ester) lubricants must be used with R-32 or R-454B equipment.
- To prevent moisture absorption and lubricant contamination, do not leave the refrigeration system open to the atmosphere for extended periods of time.
- If unit refrigerant is low, recover the refrigerant, evacuate, and recharge unit to nameplate amount.
- If there is any amount of refrigerant in the system charge from the low side.
- Always charge by liquid inverted.

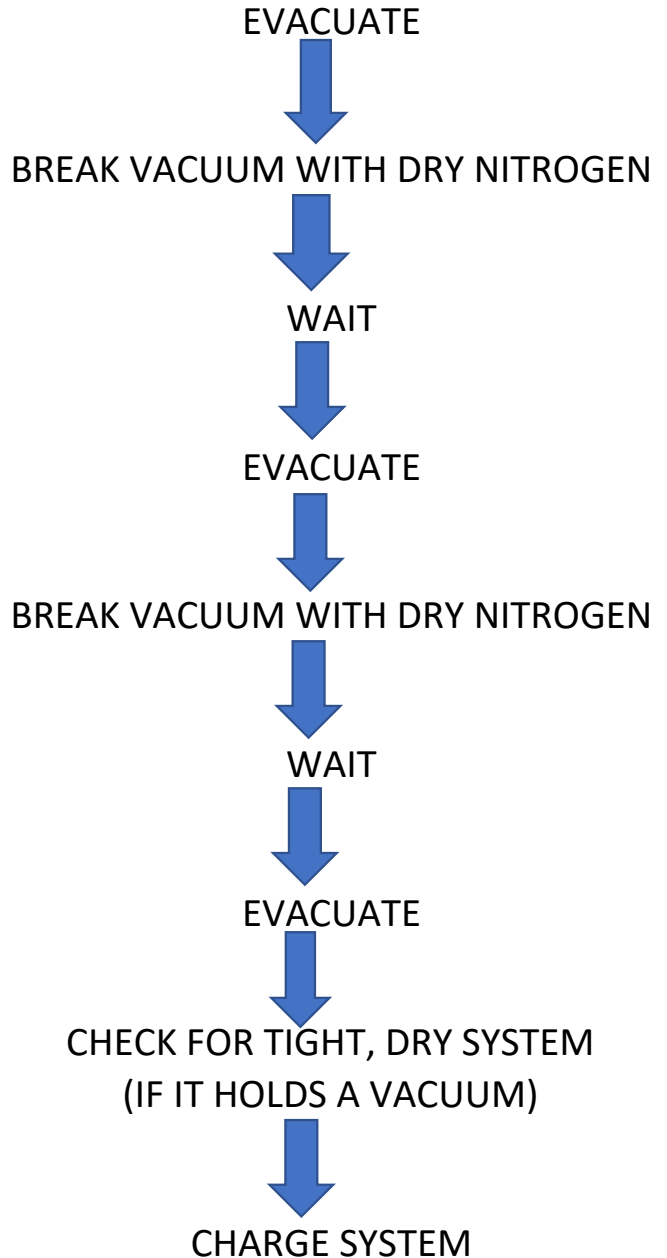

Figure G.1

G. LEAK CHECK AND CHARGING AND TRIPLE EVACUATION

Friedrich requires all installations are Leak Checked and Evacuated in accordance to the "triple evacuation" process. This process promotes a dry tight refrigeration system before opening the service valves. It recommended that a single port refrigeration manifold and hoses rated over 31.5psi be used. Refrigeration hose valves, along with a vacuum pump and micron gauge, must be used to ensure the system can be vacuumed and held under 500 microns. Check all equipment and hoses for proper usage and leaks before beginning.

1. 1st Nitrogen Pressure Test:

Ensure all refrigeration connections are properly flared, secured, and torqued to their respective settings.

Pressurize the system with nitrogen to 550psi. Soap all connections with an approved refrigerant leak detection solution.

The pressure in the system must hold for one hour respective to the environmental conditions and should not vary less than 540psi. If pressure can not be adequate held, check integrity of flares and torque specifications. Once pressure is held adequately, purge the nitrogen charge to system pressure of 5-10psi. DO NOT RETURN TO ATMOSPHERIC PRESSURE.

2. 1st Vacuum Micron Test:

Connect hoses and vacuum pump to the outdoor unit as shown in Fig. 436. Start the vacuum pump and vacuum to 1000 microns. Close the valve to the vacuum pump and check for micron rise for 15 minutes. If microns rise to near atmospheric pressure, there is a potential leak; repeat step 1. If microns rise over 5000, the system is very wet and will require further nitrogen purges.

3. 2nd Nitrogen Break:

Once the system holds below 5000 microns, reconnect the nitrogen tank break the system vacuum with 30-50psi of nitrogen. Wait 5 minutes, then purge to 5-10psi. DO NOT RETURN TO ATMOSPHERIC PRESSURE.

4. 2nd Vacuum Micron Test:

Reconnect vacuum pump and gauge and begin evacuation. Vacuum system to 500 microns. Close vacuum valve and check for micron rise. Vacuum should hold under 1000 microns. Repeat steps 3 and 4 until achieved.

5. 3rd Nitrogen Break:

Once the system holds below 1000 microns, reconnect the nitrogen tank break the system vacuum with 30-50psi of nitrogen. Wait 5 minutes, then purge to 5-10psi. DO NOT RETURN TO ATMOSPHERIC PRESSURE.

6. 3rd Final Vacuum Micron Test:

Reconnect vacuum pump and gauge and begin evacuation. Vacuum system to 300 microns. Close vacuum valve and check for micron rise. Vacuum should hold under 500 microns. Repeat steps 3 and 4 until achieved. Once held under 500 microns, the system is considered dry and tight.

7. Charging the system:

Unscrew Service Valve Caps to expose the inner hexagon head. Use an allen-head spanner or service wrench with appropriate adapter to release the refrigerant into the system. If the calculated line set length is over 2 ft, weight in the additional charge with an approved refrigerant scale as needed. Refer to Table G.1.

Capacity (Btu/h)	Refrigerant Pre-Charge	Pipe Size		Standard Length (ft)	Max. Elevation H (ft)	Max. Length L (ft)	Additional Refrigerant (oz/ft)
		LIQUID	GAS				
FPHSR09A1C	33.5 oz	1/4"	3/8"	25	50	66	.22
FPHSR09A3D	35.2 oz	1/4"	3/8"	25	50	66	.22
FSHSR09B1C	21.2 oz	1/4"	3/8"	25	50	66	.22
FPHSR12A1C	35.3 oz	1/4"	3/8"	25	50	66	.22
FPHSR12A3D	38.1 oz	1/4"	3/8"	25	50	66	.22
FSHSR12B1C	21.9 oz	1/4"	3/8"	25	50	66	.22
FPHSR18A3D	53 oz	1/4"	1/2"	25	50	100	.22
FSHSR18B3D	45.9 oz	1/4"	1/2"	25	50	100	.22
FPHSR24A3D	70.6	3/8"	5/8"	25	50	100	.32
FSHSR24B3D	47.6	3/8"	5/8"	25	50	100	.32
FSHSR36B3D	70.6	3/8"	5/8"	25	50	100	.43

Table G.2

Figure G.3

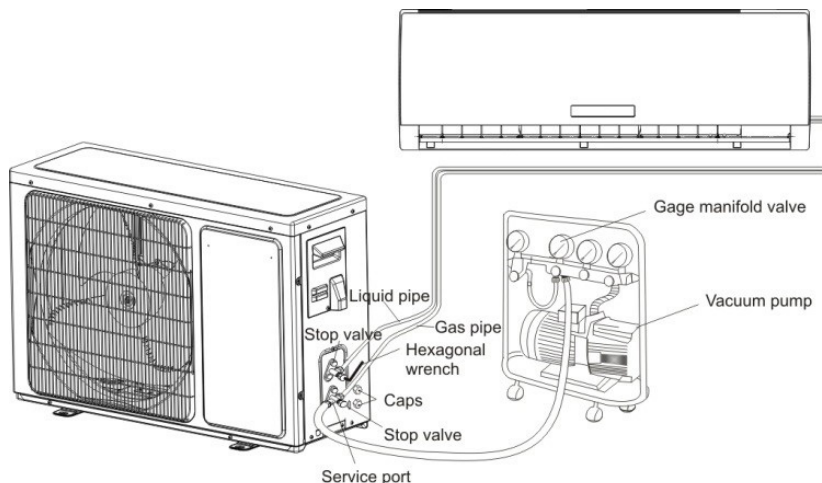

J. STARTUP AND OPERATION

J.1 Checklist and Operation Test

Present the owner or operator of the equipment with the Installation & Operation Manual, all accessory installation instructions, and the name, address, and telephone number of the Authorized Friedrich Warranty Service Company in the area for future reference if necessary. Inspect the unit for any damage to the coils and tubing that could cause a leak.

NOTICE

This unit is certified to operate in cooling mode under these maximum conditions. Any operation beyond these conditions may result in intermittent operation.

Indoor temperature: 90 °F (45% relative humidity)

Outdoor temperature: 110 °F (25% relative humidity)

If unit is heat pump equipped, it is certified to operate in heating mode under these maximum conditions. Any operation beyond these conditions may result in intermittent operation.

Indoor temperature: 80 °F (humidity does not affect operation)

Outdoor temperature: 75 °F (60% relative humidity)

Test Operation

System Checks

1. Conceal refrigerant pipes where possible.
2. Make sure drain hose slopes downward along entire length at a slope of 1/4"(inch) per '(foot).
3. Ensure all refrigerant pipes and connections are properly insulated.
4. Fasten pipes to outside wall, when possible.
5. Seal and weatherproof wall hole which the interconnecting wires and refrigerant pipes pass through.

Perform test operation after completing gas leak and electrical safety check.

1. Turn on electrical disconnect to outdoor unit.
2. Push the "ON/OFF" button on Remote Controller to begin testing or press and hold Emergency ON/OFF button for 5 seconds to force test mode.
3. Push MODE button, select COOLING, HEATING, FAN mode to confirm all functions.

Indoor Unit

1. Do all Remote controller's buttons function properly?
2. Do the display panel lights work properly?
3. Does the swing louver function properly?
4. Does the drain work?

Outdoor Unit

1. Push the mode button to COOL and adjust the room setting to 61 °F(16°C) deg. Wait up to 3 minutes from compressor time guard. Does compressor and outdoor fan turn on in cooling mode?

2. Push the mode button to HEAT and adjust the room setting to 85 °F(30°C) deg. Wait up to 3 minutes for compressor time guard. Does compressor and outdoor fan turn on in heat mode?

No.	Items to be checked	Possible malfunction
1	Has the unit been installed correctly?	The unit may drop, shake or emit noise.
2	Have you done the refrigerant leakage test?	It may cause insufficient cooling (heating) capacity.
3	Is heat insulation of pipeline sufficient?	It may cause condensation and water dripping.
4	Is water drained well?	It may cause condensation and water dripping.
5	Is the voltage of power supply according to the voltage marked on the nameplate?	It may cause malfunction or damage the parts.
6	Is electric wiring and pipeline installed correctly?	It may cause malfunction or damage the parts.
7	Is the unit grounded securely?	It may cause electric leakage.
8	Does the power cord follow the specification?	It may cause malfunction or damage the parts.
9	Is there any obstruction in air inlet and air outlet?	It may cause insufficient cooling (heating).
10	Are the dust and debris caused during installation removed?	It may cause malfunction or damaging the parts.
11	The gas valve and liquid valve of connection pipe are open completely?	It may cause insufficient cooling (heating) capacity.

Installation Manual

DUCTLESS SPLIT SYSTEMS

(Para unidad externa)



ESPAÑOL

Contenido

Instrucciones de seguridad	1
Preparación antes del uso	3
Programación	3
Protección del medio ambiente	3
Precauciones de seguridad	5
Instrucciones para la instalación	6
Diagrama de instalación	6
Herramientas sugeridas	7
Instrucciones del sitio	8
Instalación de la unidad externa	9
Energía y cableado	11
Prueba de vacío y carga	13

Refiérase a INSTRUCCIONES PARA LA INSTALACIÓN Y EL USO de la unidad interna sólo para unidades externas.

***Instrucciones del funcionamiento del control remoto.
Ver "Instrucciones del control remoto".***

Instrucciones de seguridad

- 1. Para garantizar que la unidad funcione con normalidad, leer cuidadosamente el manual antes de la instalación y realizar la instalación siguiendo este manual.
- 2. Al mover el aire acondicionado, no dejar que el aire ingrese al sistema de refrigeración o a la descarga del refrigerante.
- 3. Conectar el aire acondicionado a tierra de manera correcta.
- 4. Verificar cuidadosamente los cables y la tubería. Asegurar de que estén correctos y firmes antes de conectar la electricidad.
- 5. Debe haber un interruptor de aire.
- 6. Luego de la instalación, el usuario debe operar el aire acondicionado de manera correcta según el manual. Tener un lugar de almacenamiento correcto para el mantenimiento y traslado del aire acondicionado en el futuro.
- 7. El fusible de la unidad:
See GRÁFICO E.1

- 8. Se debe incorporar en el cableado fijo un Dispositivo de Corriente Residual (RCD por sus siglas en inglés) con un rango superior a 10mA según las normas nacionales.
- 9. Advertencia: Riesgo de descarga eléctrica: puede causar lesiones o la muerte. Desconectar todos los suministros eléctricos remotos antes de realizar el servicio.
- 10. La mejor longitud de la tubería de conexión entre la unidad interna y la externa es menos que 7,5 metros (24,6 pies). Si la distancia es mayor que la longitud afectará la eficiencia del aire acondicionado.
- 11. Este electrodoméstico no está destinado para ser utilizado por personas (incluidos niños) con capacidades mentales, sensoriales y físicas reducidas o falta de experiencia y conocimiento, a menos que hayan sido supervisados o instruidos sobre el uso del electrodoméstico por una persona responsable por su seguridad. Se debe supervisar a los niños pequeños para asegurarse de que no jueguen con el electrodoméstico.
- 12. Este electrodoméstico puede ser utilizado por menores de 8 años en adelante y por personas con capacidades físicas, sensoriales o mentales reducidas o falta de experiencia o conocimiento sólo si han sido supervisados o instruidos sobre el uso del electrodoméstico en una forma segura y hayan entendido los peligros que incluye. Los niños no deben jugar con el electrodoméstico. La limpieza y el mantenimiento no debe realizarse por los niños sin supervisión.
- 13. Las pilas del control remoto se deben reciclar o desechar de manera correcta. Eliminación de las pilas --- Desechar las pilas como desechos municipales en el punto de recolección.

Instrucciones de seguridad

- 14. Si el electrodoméstico es de instalación fija, debe estar equipado con medios de desconexión desde el suministro y una separación de contacto en todos los polos que brinden una desconexión completa bajo una sobretensión de categoría III; estos medios se deben incorporar en la instalación fija según las normas de instalación eléctrica.
- 15. Para evitar peligros, si el cable de suministro está dañado, lo debe reemplazar el fabricante, el agente de servicio o una persona similar calificada.
- 16. Se debe instalar el electrodoméstico según las normas de seguridad eléctrica local y el Código Nacional de Electricidad (NEC, por sus siglas en inglés).
- 17. El aire acondicionado debe ser instalado por un profesional o personas calificadas.
- 18. No se debe instalar el electrodoméstico en la sala de lavandería.
- 19. En relación a la instalación, refiérase a la sección "Instrucciones para la instalación".
- 20. En relación al mantenimiento, refiérase a la sección "Cuidado y mantenimiento".
- 21. Para los modelos que utilizan refrigerante R32 y R454B, la conexión de las tuberías debe realizarse en el lado exterior.

Preparación antes del uso

Nota

- Cuando cargue refrigerante en el sistema, asegúrese de que que esté en estado líquido si el refrigerante del aparato es R32 y R454B. De lo contrario, la composición química del refrigerante (R32 y R454B) en el interior del sistema podría cambiar y afectar al rendimiento del climatizador.
- De acuerdo con el carácter del refrigerante (R32 y R454B, el valor de GWP es 675 y 466), la presión del tubo es muy elevada, así que sea cauteloso cuando instale y repare el aparato.
- Para evitar riesgos, si el cable de suministro está dañado, lo debe reemplazar el fabricante, el agente de servicio o una persona similar calificada.
- El aire acondicionado debe ser instalado por personas capacitadas y calificadas o por el servicio mecánico.
- La temperatura del circuito refrigerante será alta, mantener el cable de interconexión lejos del tubo de cobre.

Programación

Antes de utilizar el aire acondicionado, verificar y programar lo siguiente.

• Programación del control remoto

Cada vez que se reemplazan las pilas del control remoto con pilas nuevas o que se energiza, la configuración automática del control remoto es bomba de calor. Si el aire acondicionado que compró es Cooling Only (Solo frío), también se puede utilizar el control remoto para bomba de calor.

- Función de luz de fondo el control remoto (opcional)

Mantener presionado cualquier botón del control remoto para activar la luz de fondo. Se apaga automáticamente después de 10 segundos.

Nota: La luz de fondo es una función opcional.

• Programación Auto Restart

El aire acondicionado tiene la función de Auto-Restart (Reinicio automático).

Protección del medio ambiente

Este electrodoméstico está hecho de materiales reciclables o reutilizables. El descarte debe llevarse a cabo de acuerdo a las normas locales de desecho. Antes de realizar el descarte, cortar el cable principal para que el electrodoméstico no se pueda reutilizar.

Para una información más detallada sobre el manejo y reciclaje del producto, contactar a las autoridades locales que se encargan de la separación de basura o a la tienda donde compró el electrodoméstico.

DESARME DEL ELECTRODOMÉSTICO

Este aparato tiene está certificado bajo la Directiva Europea 2012/19/EC de residuos de aparatos eléctricos y electrónicos (RAEE).





Esta marca indica que el producto no puede desecharse con otros desperdicios del hogar en todo Norte América. Para evitar posibles daños al ambiente o a la salud humana debido a la eliminación de desechos sin control, reciclar responsablemente para promover la reutilización sustentable de los recursos materiales. Para devolver el dispositivo usado, utilizar los sistemas de devolución y colección o contactar al distribuidor donde compró el producto.

Ellos pueden tomar este producto para reciclar y cuidar el ambiente.



Precauciones de seguridad























Explicación de los símbolos que se muestran en la unidad interna y externa.

 <small>Caution, risk of fire</small>	ADVERTENCIA	<p>Este símbolo muestra que el electrodoméstico utiliza refrigerante inflamable. Si el refrigerante se escapa o se expone a una fuente de ignición externa, hay riesgo de incendio</p>
	PRECAUCIÓN	<p>Este símbolo muestra que se debe leer cuidadosamente el manual de instrucciones.</p>
	PRECAUCIÓN	<p>Este símbolo muestra que personal de servicio debería manejar el equipo siguiendo el manual de instalación.</p>
	PRECAUCIÓN	<p>Este símbolo muestra que la información está disponible, tanto el manual de instrucciones como el manual de instalación.</p>
A2L	ADVERTENCIA	<p>El refrigerante se denomina según la clasificación de seguridad ASHRAE, con inflamabilidad leve y baja toxicidad.</p>

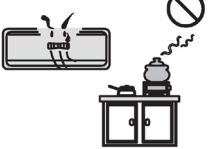
Precauciones de seguridad

Los símbolos en este Manual de Uso y Cuidado se especifican a continuación.

-  No hacerlo.
-  La conexión a tierra es esencial.
-  Prestar atención a la situación.
-  Advertencia: El manejo incorrecto puede causar serios peligros como la muerte, lesiones graves, etc.

 <p>Utilizar un suministro de energía correcto según el requisito de rango de la placa. De lo contrario, pueden ocurrir fallas graves, peligros o hasta un incendio.</p>	  <p>Evitar que el disyuntor del circuito de suministro de energía o el enchufe tenga polvo. Conectar el cable de suministro de energía de manera firme y correcta para que no haya descargas eléctricas o incendios debido al mal contacto.</p>	   <p>No utilizar un disyuntor del suministro de energía o tirar del enchufe durante el funcionamiento. Esto puede causar un incendio debido a las chispas, etc.</p>
  <p>No unir, tirar o presionar el cable de suministro de energía para que no se rompa el cable. Puede ocurrir una descarga eléctrica o incendios si se rompe el cable.</p>	  <p>Nunca se debe colocar un palo o un artículo similar en la unidad. Ya que el ventilador rota a gran velocidad, esto puede causar daños.</p>	  <p>El aire fresco en contacto con Ud. durante un largo tiempo es perjudicial para su salud. Se aconseja que el flujo de aire se desvíe por toda la habitación.</p>
  <p>Apagar el electrodoméstico con el control remoto primero antes de cortar el suministro de energía en caso de que ocurra un mal funcionamiento.</p>	  <p>No debe reparar el electrodoméstico usted mismo. Si se hace de manera incorrecta, puede causar descargas eléctricas, etc.</p>	  <p>Evitar que el flujo de aire esté en contacto con quemadores de gas y hornos.</p>
  <p>No tocar los botones cuando sus manos estén húmedas.</p>	  <p>No colocar ningún objeto en la unidad interna.</p>	  <p>Es responsabilidad del usuario que el electrodoméstico esté conectado a tierra por un técnico con licencia, según los códigos locales u ordenanzas.</p>

Instrucciones para la instalación

Diagrama de instalación

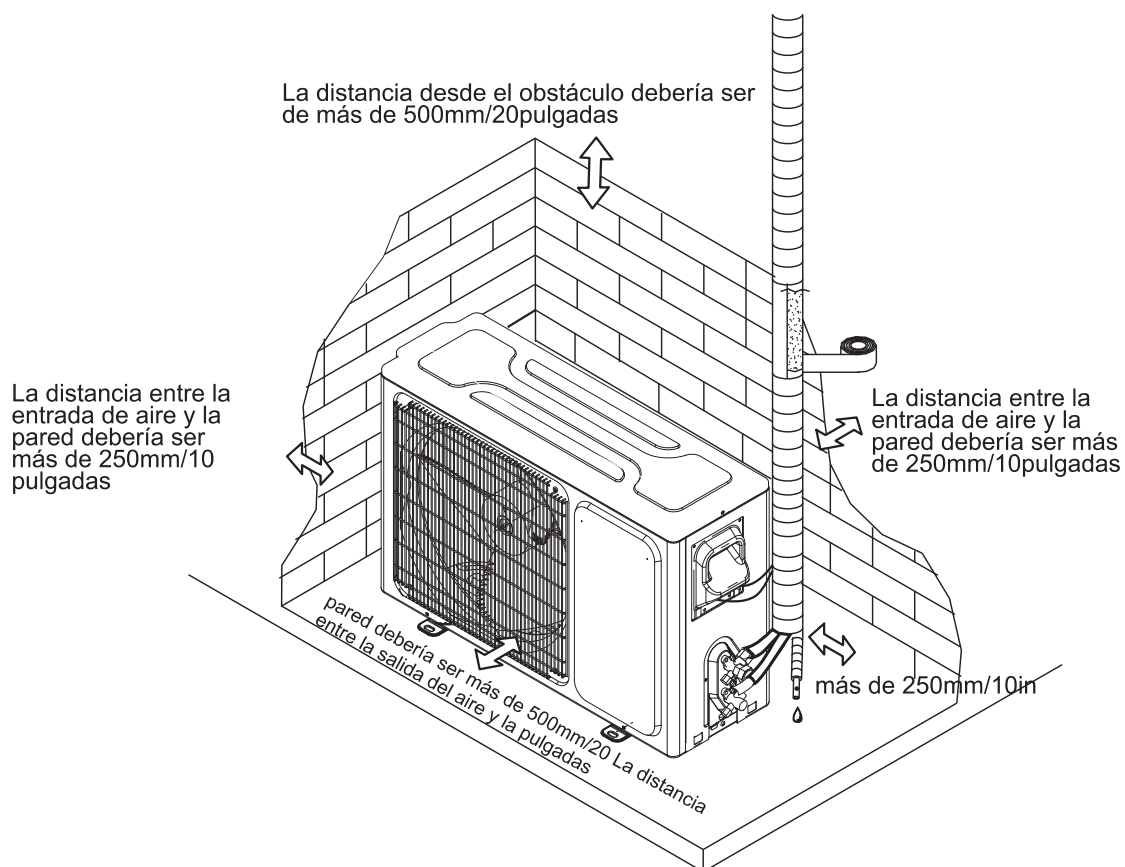

Unidad externa



- La imagen de arriba es solo una simple presentación de la unidad. Puede que no coincida con la apariencia externa de la unidad que compró.
- La instalación debe ser realizada según los estándares de instalación eléctrica nacional y por personal autorizado.

Instrucciones para la instalación

Herramientas sugeridas

Para instalar el aire acondicionado de manera convencional y segura debería utilizar las herramientas especiales que se mencionan a continuación.



Llave inglesa estándar



Destornillador

Llave hexagonal o llave Allen



Llave ajustable/creciente

Llave de torsión



Taladro y brocas

Colector y medidores



Bomba de vacío

Abrazadera y amperímetro



Nivelador

Guantes de trabajo



Guantes de seguridad



Cortatubos

Escala de refrigerante

Abocardador R410A

Medidor de micrones

Sierra de perforación

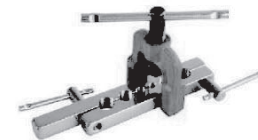

Instrucciones del sitio

Sitio para instalar la unidad externa

- Donde sea conveniente instalar y muy ventilado.
- Evite instalar donde haya fugas de gas inflamable.
- Mantenga la distancia requerida desde la pared.
- Mantenga la unidad externa lejos de polvos, salidas de gas de vulcanización.
- Evite instalar cerca de la calle donde hay riesgo de agua fangosa.
- Una base fija para que no incremente el ruido del funcionamiento.
- Donde nada bloquee la salida de aire.
- Evite instalarla bajo la luz directa del sol, en un pasillo o cerca de fuentes de calor y ventiladores. Manténgala lejos de materiales inflamables, niebla espesa de aceite y lugares húmedos o irregulares.

Unidad externa

La longitud de la tubería es 20 metros (65,4 pies) Máx.

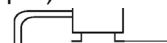

Unidad interna

La altura debería ser menos que 5m, (16,4 pies)

(La unidad exterior es más alta que la unidad interior)

- En caso de que la longitud de la tubería sea más que 7,5m (24,6pies), el refrigerante debería ser cargado adicionalmente según la siguiente tabla.

Capacidad (Btu/h)	Precarga de refrigerante	Tamaño de la tubería		Estándar Largura (ft)	Max. Elevation H (ft)	Máximo. Elevación L (ft)	Adicional Refrigerante (oz/ft)
		LÍQUIDO	GAS				
FPHSR09A1C	33.5 oz	1/4"	3/8"	25	50	66	.22
FPHSR09A3D	35.2 oz	1/4"	3/8"	25	50	66	.22
FSHSR09B1C	21.2 oz	1/4"	3/8"	25	50	66	.22
FPHSR12A1C	35.3 oz	1/4"	3/8"	25	50	66	.22
FPHSR12A3D	38.1 oz	1/4"	3/8"	25	50	66	.22
FSHSR12B1C	21.9 oz	1/4"	3/8"	25	50	66	.22
FPHSR18A3D	53 oz	1/4"	1/2"	25	50	100	.22
FSHSR18B3D	45.9 oz	1/4"	1/2"	25	50	100	.22
FPHSR24A3D	70.6	3/8"	5/8"	25	50	100	.32
FSHSR24B3D	47.6	3/8"	5/8"	25	50	100	.32
FSHSR36B3D	70.6	3/8"	5/8"	25	50	100	.43

Table G.2

Si la altura o la longitud de la tubería está fuera del alcance de la tabla, consultar al comerciante.

La instalación de la unidad interna se refiere al manual de instalación de la unidad externa.

Instalación de la unidad externa

1. Instalar el drenaje condensado para la unidad externa.

La condensación se drena desde la unidad externa cuando la unidad funciona en modo Heating. Para no molestar al vecino y proteger el medio ambiente, instalar un puerto de drenaje y una manguera de drenaje para dirigir el agua condensada. Instalar el puerto de drenaje y la arandela de goma en el chasis de la unidad externa. Luego, conectar una manguera de drenaje al puerto como se muestra en la figura de la derecha.

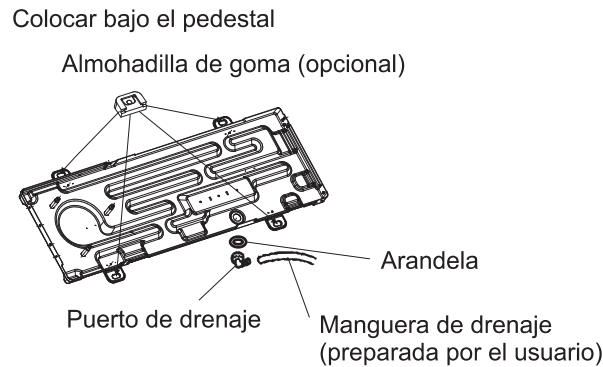

2. Instalar la placa a tierra o los ganchos de la pared.

1. Determinar la ubicación adecuada para la unidad externa.
 2. Seguir las instrucciones brindadas por el fabricante para instalar los ganchos de la almohadilla de goma en la pared.
 3. Verificar que los ganchos o la almohadilla de goma puedan soportar el peso de la unidad externa.
 4. Verificar que los ganchos o la almohadilla de goma estén a nivel y cumplan con las dimensiones de la unidad externa.
 5. Fijar con pernos y tuercas sobre un piso plano y fuerte.
- Si se instala en la pared o en el techo, fijar bien el soporte para evitar sacudidas debido a las vibraciones o vientos fuertes.

Instrucciones para la instalación

ADVERTENCIA

Los requerimientos de carga de viento de Florida establecen que la unidad externa debe estar asegurada a una base concreto de 3/8 pulgadas de diámetro, perno, cuña (o equivalente) con arandelas de 1 pulgada. Los pernos de anclaje deben estar incrustados al concreto de 3000 PSI mínimo a una distancia de 4 1/2 pulgadas desde el borde del concreto. El espesor del concreto debe exceder 1,5 veces la profundidad del perno.

3. Conexión de la tubería a la unidad externa

- Quitar el cobertor de la válvula de servicio (si se proporciona) para acceder a los puertos de las válvulas de servicio y refrigerantes.
- Doblar cuidadosamente y ajustar el largo de la tubería refrigerante para cubrir la conexión de las válvulas de servicio de la unidad externa con las herramientas adecuadas para evitar torceduras.
- Aplicar una cantidad pequeña de aceite refrigerante en la conexión de tubería refrigerante.
- Alinear adecuadamente la tubería y ajustar la tuerca utilizando una llave estándar o una llave de torsión como se muestra en la sección de tubería interna.
- Ajustar cuidadosamente la tuerca para corregir el nivel de torque como en la siguiente tabla de torque:



Tabla de torque

Diámetro de la tubería/pulgada (mm)	Tamaño de la tuerca/pulgada (mm)	Par de torsión	
		ft-lbs	N-m
1/4(6.35)	1/4(17)	11 hasta 15	15 hasta 20
3/8(9.5)	3/8(22)	22 hasta 26	30 hasta 35
1/2(12.7)	1/2(25)	37 hasta 41	50 hasta 55
5/8(15.9)	5/8(29)	44 hasta 48	60 hasta 65
3/4(19)	3/4(32)	52 hasta 55	70 hasta 75

Nota: Si se aprieta demasiado se puede dañar la tuerca de conexión y causar fugas.

ESPAÑOL

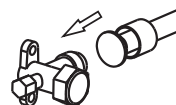
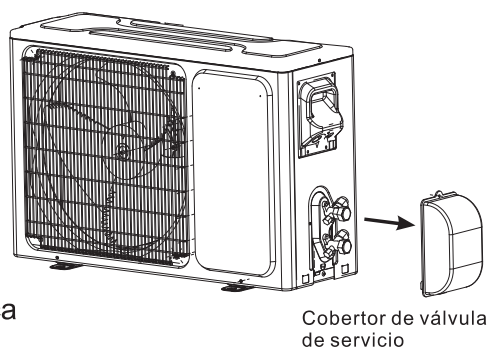
Conexión del cable

• Unidad externa

- 1) Quitar el tablero de la unidad desajustando el tornillo. Conectar los cables a la terminal del tablero de manera individual de la siguiente manera.
- 2) Asegurar el cable de alimentación en el tablero de control con una abrazadera.
- 3) Volver a instalar el tablero de la unidad a su posición original con un tornillo.
- 4) Utilizar un disyuntor entre la fuente de alimentación y la unidad. Se debe proporcionar un dispositivo de desconexión para desconectar todas las líneas de suministro.

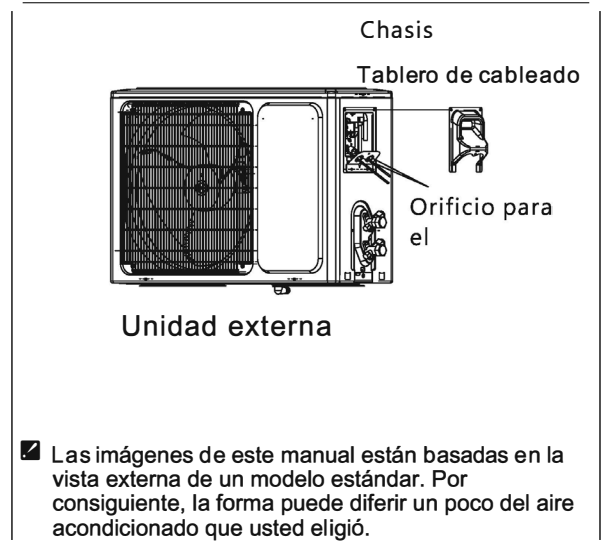

Precaución:

1. Nunca se debe dejar de tener un circuito de energía individual específico para el aire acondicionado. Para los métodos del cableado, ver el diagrama del circuito publicado dentro del acceso de la puerta.
2. Confirmar que el espesor del cable sea tan específico como en las especificaciones de la fuente de energía.
3. Verificar los cables y asegurar que estén bien sujetos después de la conexión.
4. Instalar un disyuntor de fugas a tierra en áreas húmedas o mojadas.

Cable Specifications

Modelo	Diámetro del cable (AWG) Cable de interconexión entre la unidad interior y exterior	Fuente de alimentación principal a la unidad exterior		
		Tamaño del cable	MOP (Clasificación de dispositivo de sobrecorriente)	MCA (Ampacidad mínima del circuito)
FPHSR09A1C	14-4 AWG 600V THHN	Tamaño según códigos eléctricos locales y nacionales.	25A	16A
FPHSR09A3D	14-4 AWG 600V THHN		15A	9.5A
FSHSR09B1C	14-4 AWG 600V THHN		25A	14.6A
FPHSR12A1C	14-4 AWG 600V THHN		25A	16A
FPHSR12A3D	14-4 AWG 600V THHN		15A	10.5A
FSHSR12B1C	14-4 AWG 600V THHN		25A	15.4
FPHSR18A3D	14-4 AWG 600V THHN		30A	20A
FSHSR18B3D	14-4 AWG 600V THHN		20A	14.5A
FPHSR24A3D	14-4 AWG 600V THHN		35A	22A
FSHSR24B3D	14-4 AWG 600V THHN		35A	21A
FSHSR36B3D	14-4 AWG 600V THHN		40A	25.8A

Table E.1

Atencion:

El enchufe debe estar accesible a(m despues de la instalaci3n del electrodomestico en caso de necesitar desconectarlo. Si no es posible, conectar el electrodomestico a un interruptor bipolar con una separacion de contacto de al menos 3mm colocado en una posicion accesible despues de la instalacion.

Instrucciones de instalación

Diagrama de cableado

Asegúrese de que el color de los cables de la unidad exterior y el n.º de terminal sean iguales que los de la unidad interior.

1) 208/230V

Terminal de la unidad interior

Terminal de la unidad exterior

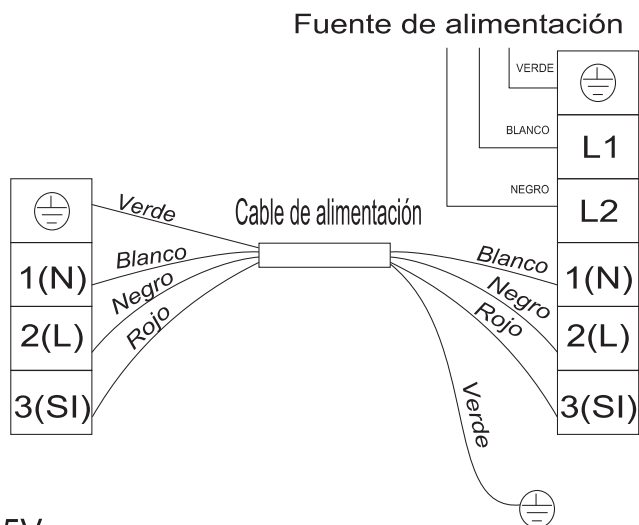

2) 115V

Terminal de la unidad interior

Terminal de la unidad exterior

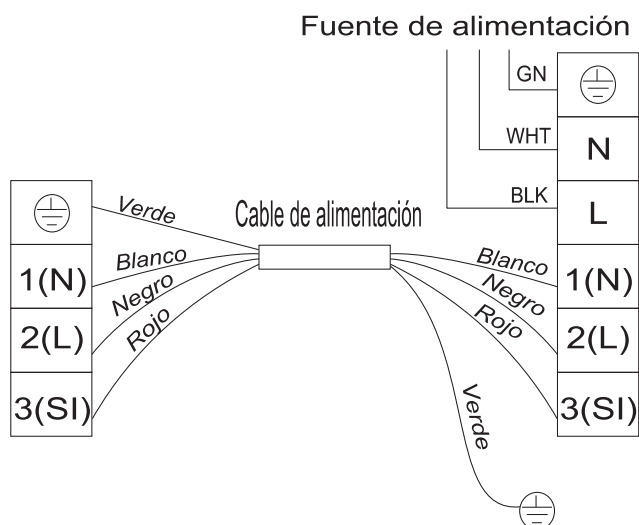

☑ El diagrama es solo de referencia; se deben seguir los terminales reales del producto.

Prueba de vacío y carga

El aire que contiene humedad en el ciclo de refrigeración puede causar un mal funcionamiento en el compresor. Luego de conectar las unidades internas y externas, liberar el aire y la humedad del ciclo refrigerante utilizando una bomba de vacío como se muestra a continuación.

Nota: Para proteger el ambiente, no descargar el refrigerante en el aire directamente. Ver la siguiente página para los pasos de purga de aire.

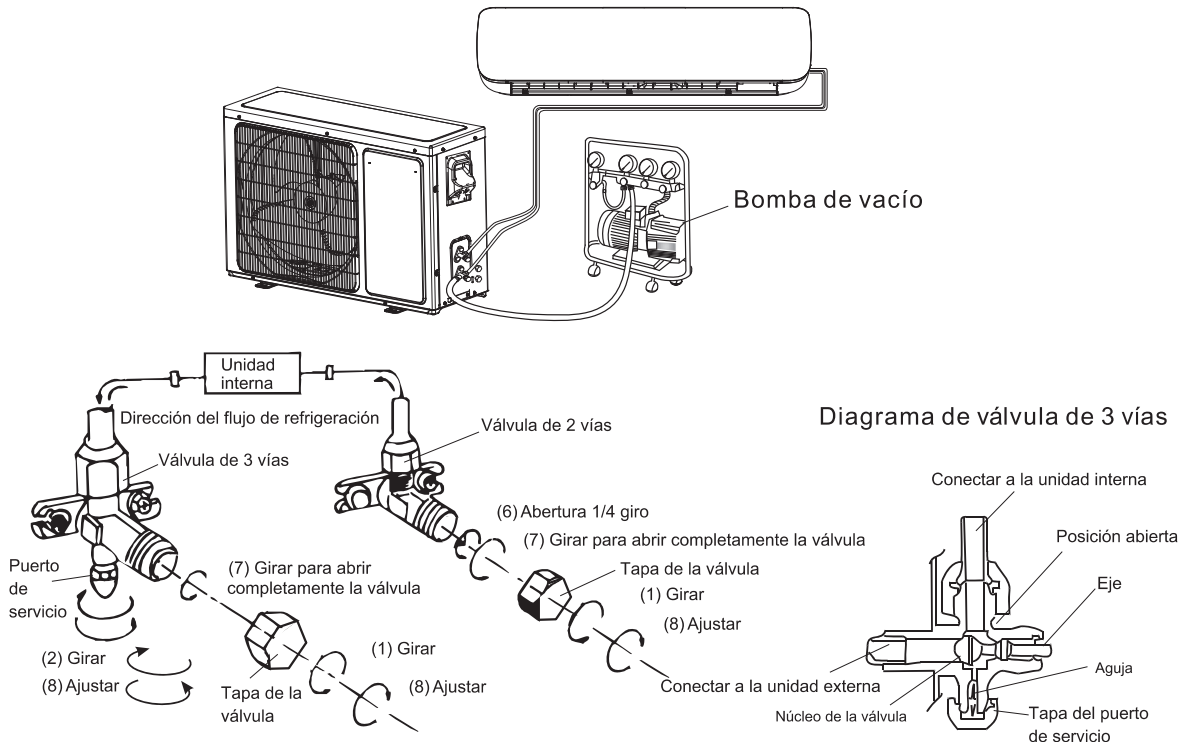

Cómo aspirar los tubos de aire:

- (1) Desatornillar y quitar las tapas de las válvulas de 2 y 3 vías.
- (2) Desatornillar y quitar la tapa de la válvula de servicio.
- (3) Conectar la manguera flexible de la bomba de vacío a la válvula de servicio.
- (4) Comenzar el bombeo por 10-15 minutos hasta alcanzar 100mm HG absolutos.
- (5) Con la bomba de vacío aún funcionando, cerrar la perilla de presión baja del colector de la bomba de vacío. Luego, parar el bombeo de vacío.
- (6) Abrir la válvula de 2 vías 1/4 giro y 10 segundos después cerrarla. Verificar el ajuste de las juntas utilizando jabón líquido o un detector electrónico de fugas.
- (7) Girar el vástago de las válvulas de 2 y 3 vías para cerrar completamente las válvulas. Desconectar la manguera flexible de la bomba de vacío.
- (8) Reemplazar y ajustar las tapas de todas las válvulas.

Installation Manual

DUCTLESS SPLIT SYSTEMS

(Unité Extérieur)

FRANÇAIS



Table des matières

Consignes de sécurité	1
Préparation post-utilisation	3
Préréglage	3
Respect de l'environnement	3
Consignes de sécurité	5
Consignes d'installation	6
Schéma d'installation	6
Outils suggérés	7
Consignes relatives au site	8
Installation de l'unité extérieure	9
Alimentation et câblage	11
Charge et décharge	13

Pour l'unité extérieure seulement, veuillez vous référer aux INSTRUCTIONS D'UTILISATION ET DE MONTAGE de l'unité intérieure pour l'unité intérieure.

Pour les consignes d'utilisation de la télécommande, voir la rubrique « Consignes d'utilisation de la télécommande »

Consignes de sécurité

- 1. Afin de garantir le fonctionnement correct de cet appareil, merci de lire attentivement cette notice avant d'installer le climatiseur, en tenant de respecter les consignes qui y sont livrées.
- 2. Ne laissez l'air pénétrer ni à l'intérieur du système de réfrigération ni à l'intérieur du système d'évacuation du liquide frigorigène lorsque vous déplacez l'appareil.
- 3. Reliez correctement l'appareil à la terre.
- 4. Vérifiez les câbles et conduits de raccordement attentivement. Assurez-vous qu'ils sont en bon état et solides avant de procéder au branchement de l'appareil.
- 5. Un interrupteur pneumatique doit être utilisé.
- 6. Une fois l'installation terminée, l'opérateur doit faire fonctionner le climatiseur conformément aux consignes fournies dans cette notice, et la conserver afin de pouvoir dépanner/entretenir le climatiseur par la suite.
- 7. Fusible de cet appareil :
Ver tabla É.1

- 8. Un interrupteur à courant différentiel, doté d'une capacité minimum de 10mA, doit être intégré aux câbles fixes, conformément aux Règlements Nationales en vigueur.
- 9. Mise en garde : risque d'électrocution, susceptible d'entraîner de graves blessures, voire la mort. Débranchez toutes les sources d'alimentation électriques à distance avant de procéder à la manipulation des dispositifs.
- 10. La meilleure longueur de raccordement entre l'unité intérieure et l'unité extérieure se situe en dessous de 7,5 mètres (24,6pieds). Si la distance recommandée n'était pas respectée, cela impacterait l'efficacité du climatiseur.
- 11. Cet appareil n'est pas conçu pour être utilisé par des personnes (y compris les enfants) ayant des capacités physiques, sensorielles ou mentales réduites, ou manquant d'expérience et de connaissances, à moins d'être supervisé ou instruit par une personne responsable de leur sécurité. Les enfants doivent être surveillés pour s'assurer qu'ils ne jouent pas avec l'appareil.
- 12. Cet appareil peut être utilisé par des enfants âgés de 8 ans et plus, ainsi que par des personnes dont les capacités mentales, physiques et sensorielles sont diminuées, ou manquant de l'expérience/des connaissances nécessaires pour le faire fonctionner, dans la mesure où elles sont placées sous la surveillance d'un tiers conscient des risques impliqués et des mesures à prendre en cas de danger. Les enfants ne doivent pas jouer avec cet appareil. Le nettoyage et la maintenance de l'appareil ne doivent pas être effectués par des enfants sans surveillance.
- 13. Les piles de la télécommande doivent être recyclées ou éliminées de façon correcte. Élimination des piles --- Merci de vous débarrasser des piles auprès du point de collecte le plus proche de chez vous, et non pas avec le reste de vos déchets domestiques.





FRANÇAIS

Consignes de sécurité

- 14. Si l'appareil est relié par un câble fixe, il doit être doté d'un système de déconnexion relié à l'alimentation principale en contact avec les différents pôles afin d'éviter les risques de surtension. Ce dispositif de sécurité doit être conforme aux Règlements électriques en vigueur.
- 15. Si le cordon d'alimentation est endommagé, vous devez le faire remplacer par le fabricant, l'un de ses agents ou un technicien qualifié, afin de réduire tous les risques présents.
- 16. Cet appareil doit être installé conformément aux Normes Électriques de Sécurité et au Code National de l'Électricité (CNE).
- 17. Le climatiseur doit être installé par un technicien qualifié et/ou agréé.
- 18. L'appareil ne doit pas être installé dans une buanderie.
- 19. En ce qui concerne le montage, veuillez vous référer à la section «Instructions de Montage».
- 20. En ce qui concerne la maintenance, veuillez vous référer à la section «Entretien et Maintenance».
- 21. Pour les modèles utilisant le réfrigérant R32 et R454B, le raccordement de la tuyauterie doit être effectué du côté extérieur.

Préparation post-utilisation

Remarque

- 
 • Lors du chargement du réfrigérant dans le système, assurez-vous de le charger à l'état liquide si le réfrigérant de l'appareil est R32 et R454B. Sinon, la composition chimique du réfrigérant (R32 et R454B) à l'intérieur du système peut changer et donc affecter les performances du climatiseur.
- 
 • Selon les caractéristiques du réfrigérant (R32 et R454B, la valeur du PRP est de 675 et 466), la pression du tube est très élevée. Veillez donc à être prudent lors de l'installation et de la réparation de l'appareil.
- 
 • Si le cordon d'alimentation est endommagé, vous devez le faire remplacer par le fabricant, l'un de ses agents ou un technicien qualifié, afin de réduire tous les risques présents.
- 
 • Le climatiseur doit être installé par un technicien qualifié et/ou agréé.
- 
 • La température du circuit de réfrigération sera élevée ; merci de maintenir le câble d'interconnexion à l'écart du tube en cuivre.

Préréglage

Avant d'utiliser le climatiseur, vérifiez et préréglez bien les éléments suivants.

• Préréglage de la télécommande

Dès que la télécommande est équipée de nouvelles piles ou chargée en électricité, la télécommande règle automatiquement la pompe à chaleur. Si le climatiseur que vous avez acheté est un modèle Cooling Only (non réversible), la télécommande ne procédera pas à ce réglage.

• Fonction de rétroéclairage de la télécommande (optionnel)

Maintenez enfoncé n'importe quelle touche de la télécommande afin d'activer le rétroéclairage. Ce dernier s'arrête de fonctionner automatiquement au bout de 10 secondes.

Remarque : la fonction de rétro-éclairage est optionnelle.

• Préréglage du Redémarrage Automatique (Auto-Restart)

Le climatiseur est doté d'une fonction de Redémarrage Automatique (Auto-Restart).

Respect de l'environnement

Le climatiseur est doté d'une fonction de Redémarrage Automatique (Auto-Restart). Respect de l'environnement

Cet appareil est constitué de matériaux ou réutilisables. L'élimination doit être effectuée conformément aux Réglementations en vigueur. Avant de vous en débarrasser, pensez bien à couper le cordon d'alimentation, pour que l'appareil ne puisse plus être utilisé.

Pour obtenir des informations plus détaillées à propos de l'élimination correcte de cet appareil, contactez les Autorités chargées de l'élimination des déchets autres que domestiques, ou la boutique auprès de laquelle vous avez acheté l'appareil.

ÉLIMINATION DE L'APPAREIL

Cet appareil est marqué conformément à la Directive Européenne 2012/19/CE relative aux Déchets d'équipements électriques et électroniques (DEEE).





Ce symbole indique que cet appareil ne peut pas être mélangé aux déchets domestiques sur le territoire Nord-américain. Afin d'éviter tout risque potentiel pour l'environnement ou l'Homme, recyclez-le de façon responsable. Cela permettra de réutiliser les ressources disponibles. Pour éliminer votre appareil, contactez les Centres de Tri agréés près de chez vous, ou rendez-vous après de la boutique où vous l'avez acheté.

Ces entités seront en mesure de vous proposer les mesures d'élimination les plus adaptées.







Mesures de sécurité

Explication des symboles utilisés sur l'unité intérieure et sur l'unité extérieure.

 Caution, risk of fire	AVERTISSEMENT	Ce symbole indique que l'appareil utilise un liquide frigorigène inflammable. Si le liquide fuit et est exposé à une source d'inflammation, il existe un risque d'incendie
	ATTENTION	Ce symbole indique que la notice d'utilisation doit être consultée.
	ATTENTION	Ce symbole indique que l'équipement doit être manipulé par un technicien qualifié, conformément aux consignes livrées dans la notice d'installation.
	ATTENTION	Ce symbole indique que des informations supplémentaires sont disponibles dans la notice d'utilisation ou d'installation.
A2L	AVERTISSEMENT	Le réfrigérant est nommé selon la classification de sécurité ASHRAE, avec une faible inflammabilité et une basse toxicité.

Consignes de sécurité

Les symboles utilisés dans cette notice sont décriptés à la suite :

-  À ne surtout pas faire.
-  Connexion au sol obligatoire.
-  Soyez vigilant dans ce genre de situation
-  Mise en garde : une mauvaise manipulation peut provoquer un risque élevé, tel qu'une blessure grave, voire le décès.



















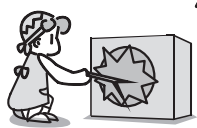

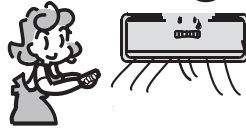

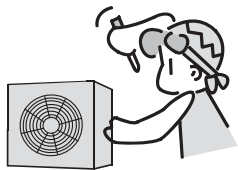

 <p>Utilisez une source d'alimentation correcte et vérifiez bien que les valeurs indiquées sur la plaque nominative sont respectées. Dans le cas contraire, cela pourrait entraîner des détériorations graves pour le système, voire générer un incendie.</p>	  <p>Vérifiez que les prises et le disjoncteur ne soient pas poussiéreux. Reliez le cordon d'alimentation fermement et selon les normes en vigueur, afin d'éviter les risques d'incendie et/ou d'électrocution dus à un mauvais contact.</p>	   <p>Ne modifiez pas la position des fusibles sur le disjoncteur pendant le fonctionnement de l'appareil. Cela pourrait provoquer des étincelles, voire déclencher un incendie, etc.</p>
  <p>Ne tordez pas, n'enfoncez pas et ne tirez pas sur le cordon d'alimentation, sous peine de fissurer les conduits électriques. Une électrocution ou un incendie pourrait alors survenir.</p>	  <p>N'insérez jamais de bâton ou objet similaire à l'intérieur de l'appareil. Dans la mesure où le ventilateur tourne à vitesse élevée, cela pourrait provoquer des blessures.</p>	  <p>Être exposé à l'air froid en continu n'est pas bon pour votre santé. Nous vous conseillons de diriger les grilles d'aération de façon à ce que l'air circule dans toute la pièce.</p>
  <p>En cas de dysfonctionnement, éteignez l'appareil au moyen de la télécommande avant de couper l'électricité.</p>	  <p>Ne réparez pas l'appareil vous-même. Si cela est mal fait, vous risqueriez de vous blesser gravement etc.</p>	  <p>Empêchez que l'air soufflé n'entre en contact avec les brûleurs à gaz et les fours.</p>
  <p>Ne touchez pas les boutons de l'appareil si vous avez les mains mouillées.</p>	  <p>Ne mettez aucun objet à l'intérieur de l'unité intérieure.</p>	   <p>Il est de votre responsabilité de vous assurer que l'appareil est relié à la terre selon les Codes électriques en vigueur ; pour cela, contactez un technicien agréé.</p>

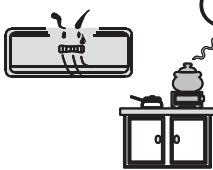
Schéma d'installation

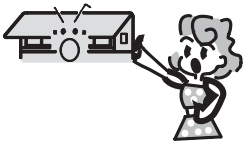

Unité Extérieure

- Le schéma ci-dessus est une représentation simplifiée de l'appareil ; il se peut qu'il ne coïncide pas précisément avec la machine que vous avez achetée.
- L'installation doit être effectuée conformément aux Règlements Nationales en vigueur, exclusivement par du personnel qualifié.

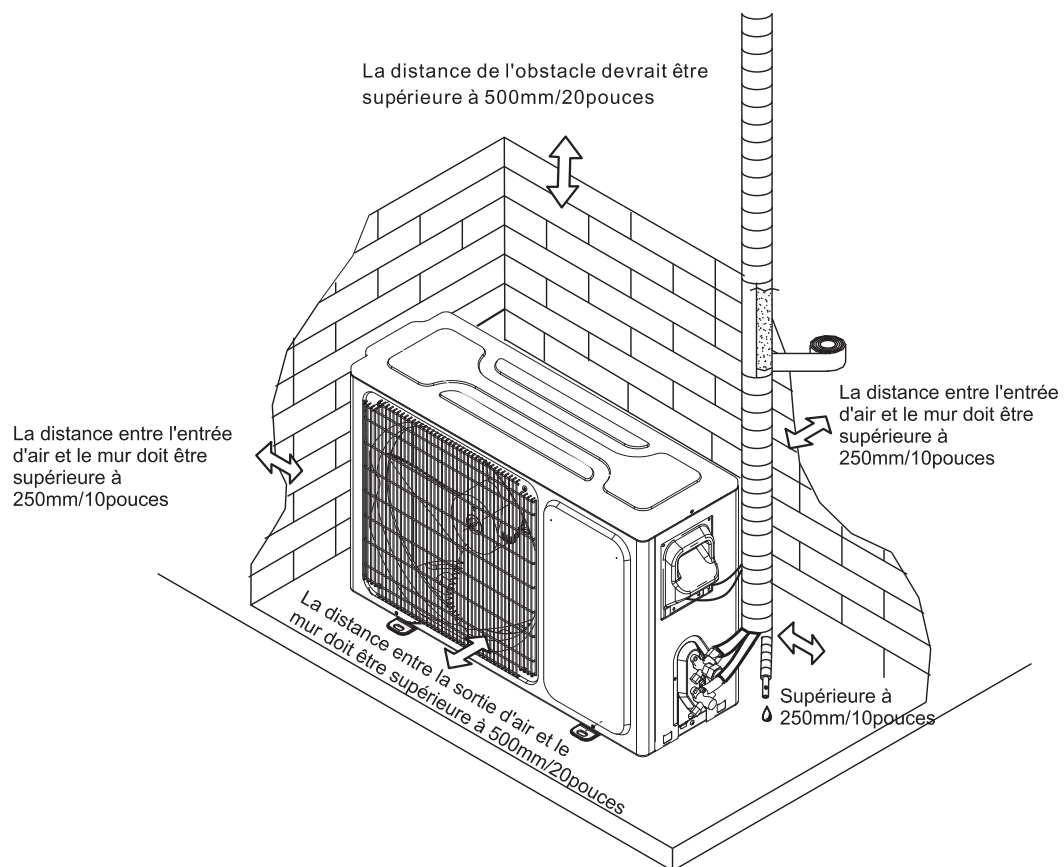
Consignes d'installation

Outils suggérés

Afin d'installer votre climatiseur de façon sécurisée et adaptée, voici une liste d'outils que vous pouvez utiliser.



Clé anglaise classique



Tournevis



Clé hexagonales ou clés Allen



Clés anglaises réglables/à molette



Clés dynamométriques



Forets et perceuse



Collecteurs et jauges



Pompe à vide

Pince / Mètre

Niveau

Gants de travail

Lunettes de sécurité

Coupe-conduits

Graduation agent frigorigène

Outil de brûlage R410A

Jauge microns

Scie cloche

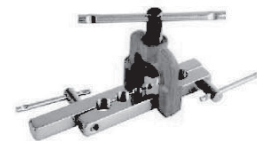

FRANÇAIS

Consignes relatives au site

Site destiné à accueillir l'unité extérieure

- Partout où l'appareil peut être installé facilement et où une bonne ventilation existe.
- Évitez d'installer l'appareil où il existe un risque possible de gaz inflammable.
- Respectez les distances recommandées entre l'appareil et les murs.
- Maintenez l'unité extérieure à l'écart des mélanges graisses/poussière, des sorties de gaz.
- Évitez d'installer l'appareil à proximité d'une route, afin d'éviter la présence de boue.
- Installez l'appareil sur une base fixe, afin d'éviter l'apparition de bruits.
- Partout où la sortie d'air n'est pas bloquée.
- Évitez d'exposer l'appareil aux rayons directs du soleil, dans un endroit trop sombre, près de la route, près de sources de chaleur et de ventilation. Maintenez-le également éloigné des substances inflammable, des huiles, et des endroits humides et peu sécurisés.
- Dans le cas où la longueur de la conduite dépasserait 7,5m (24,6 pieds), le liquide frigorigène doit être réapprovisionné, comme le montre l'illustration suivante.

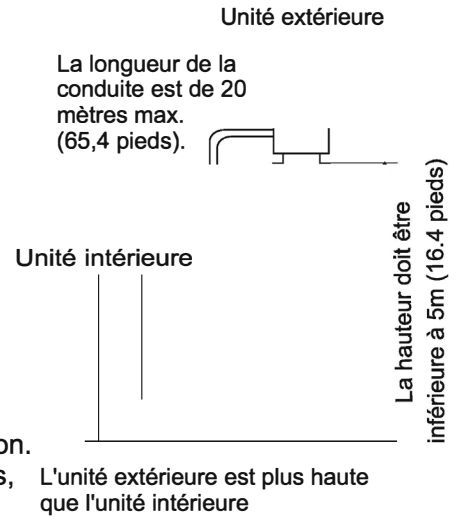

Capacité (Btu/h)	Pré-charge du réfrigérant	Pipe Size		Norme Longueur (ft)	Max. ÉlévationH (ft)	Longueur maximale L (ft)	Autres Réfrigérant (oz/ft)
		LIQUIDE	GAZ				
FPHSR09A1C	33.5 oz	1/4"	3/8"	25	50	66	.22
FPHSR09A3D	35.2 oz	1/4"	3/8"	25	50	66	.22
FSHSR09B1C	21.2 oz	1/4"	3/8"	25	50	66	.22
FPHSR12A1C	35.3 oz	1/4"	3/8"	25	50	66	.22
FPHSR12A3D	38.1 oz	1/4"	3/8"	25	50	66	.22
FSHSR12B1C	21.9 oz	1/4"	3/8"	25	50	66	.22
FPHSR18A3D	53 oz	1/4"	1/2"	25	50	100	.22
FSHSR18B3D	45.9 oz	1/4"	1/2"	25	50	100	.22
FPHSR24A3D	70.6	3/8"	5/8"	25	50	100	.32
FSHSR24B3D	47.6	3/8"	5/8"	25	50	100	.32
FSHSR36B3D	70.6	3/8"	5/8"	25	50	100	.43

Table G.2

Si la longueur de la conduite ou la hauteur ne correspondent pas aux valeurs mentionnées dans la Table, veuillez contacter le fabricant.

Consignes d'installation

Installation de l'unité extérieure

1. Installation du dispositif d'évacuation du condensat sur l'unité extérieure

L'évacuation du condensat permet de décharger l'unité extérieure lorsque cette dernière fonctionne en mode Chauffage (HEAT). Afin de ne pas déranger vos voisins et de protéger l'environnement, installez un port d'évacuation et un embout d'évacuation pour évacuer l'eau condensée. Installez simplement un port d'évacuation et une rondelle sur le châssis de l'unité extérieure, puis reliez un embout d'évacuation au port, comme sur l'illustration suivante.

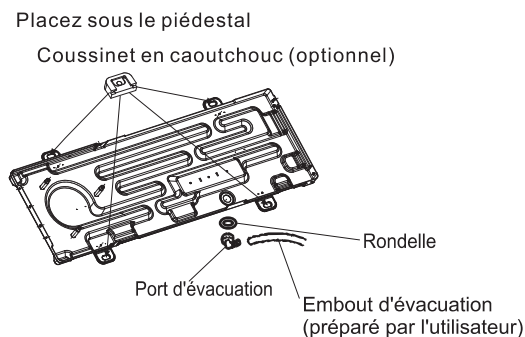

2. Installez les coussinets ou les crochets de suspension.

1. Déterminez le meilleur emplacement pour l'unité extérieure.
2. Suivez les consignes livrées par le fabricant lorsque vous installez les supports muraux.
3. Vérifiez que les fixations et/ou les coussinets peuvent supporter le poids de l'unité extérieure.
4. Vérifiez que les fixations et/ou les coussinets sont bien nivelés et respectent les espaces requis.
5. Fixez le tout au moyen de boulons et d'écrous, en prenant appui sur une surface plane et solide. Si vous installez l'unité sur un toit, assurez-vous bien que les vibrations et le vent ne risquent pas de faire chuter l'appareil.

MISE EN GARDE

Les Normes en vigueur en Floride obligent à fixer l'unité extérieure sur un socle en béton, au moyen de quatre clavettes de 3/8 pouces de diamètre (ou équivalent), ainsi qu'avec des rondelles de 1 pouce de diamètre. Les vis de fixations doivent être intégrées à une couche de béton de 3000 PSI minimum, à une distance de 4 ½ pouces des angles. Cette épaisseur ne doit pas dépasser 1,5 fois la profondeur d'ancrage.

3. Raccordements électriques de l'unité extérieure

- Retirez le cache (si le système en est muni) pour pouvoir accéder aux robinets de service et aux ports de réfrigération.
- Ajustez délicatement la longueur des conduites à liquide frigorigène afin d'atteindre les robinets de service. Utilisez les outils adaptés pour ne pas endommager le réseau.
- Appliquez un peu d'huile sur les raccords.
- Alignez correctement et serrez les vis en respectant les couples indiqués, dans la rubrique qui s'y rapporte.
- Serrez bien les vis pour que le couplage soit correct :

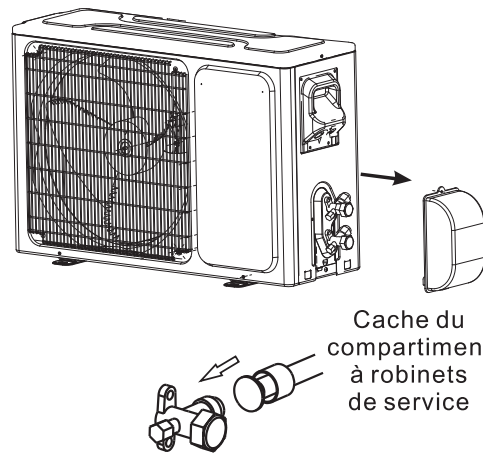

Table de couples

Diamètre de la conduite /pouces (mm)	Dimension de l'écrou /pouces (mm)	Couple de serrage	
		ft-lbs	N-m
1/4(6.35)	1/4(17)	11 à 15	15 à 20
3/8(9.5)	3/8(22)	22 à 26	30 à 35
1/2(12.7)	1/2(25)	37 à 41	50 à 55
5/8(15.9)	5/8(29)	44 à 48	60 à 65
3/4(19)	3/4(32)	52 à 55	70 à 75

Remarque : un serrage trop fort peut endommager les raccords à sertir et provoquer des fuites.

Consignes d'installation

Alimentation et câblage

Raccordement du câble

- Unité extérieure
 - 1) Retirez la section de câble de l'unité en desserrant les vis. Connectez les câbles aux bornes individuellement au panneau de contrôle, de la façon suivante.
 - 2) Sécurisez le cordon d'alimentation sur le panneau de contrôle au moyen d'une pince.
 - 3) Réinstallez la section de câble dans sa position d'origine, au moyen d'une vis.
 - 4) Installez un disjoncteur adapté au entre la source d'alimentation et l'unité. Un système de déconnexion raccordé au réseau doit être installé.

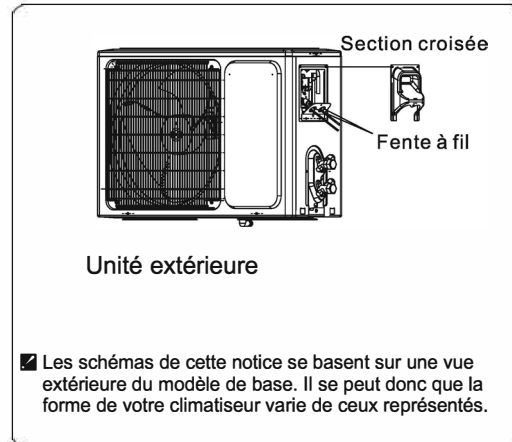

Attention :

1. N'oubliez jamais d'installer un circuit électrique individuel spécifiquement relié au climatiseur.
- En ce qui concerne la méthode de câblage, consultez le diagramme présent à l'intérieur de la porte d'accès.
2. Vérifiez que l'épaisseur des câbles est conforme à celle mentionnée sur plaque nominative
3. Vérifiez que les câbles sont bien reliés et qu'ils sont correctement serrés.
4. Pensez bien à installer un disjoncteur relié au sol dans les endroits humides ou mouillés.

Caractéristiques du câble

Modèle	Diamètre du fil (AWG) Fil d'interconnexion entre l'unité intérieure et extérieure	Alimentation principale vers l'unité extérieure		
		Taille de fil	MOP (évaluation du dispositif de surintensité)	MCA (intensité minimale du circuit)
FPHSR09A1C	14-4 AWG 600V THHN	Taille selon les codes électriques locaux et nationaux.	25A	16A
FPHSR09A3D	14-4 AWG 600V THHN		15A	9.5A
FSHSR09B1C	14-4 AWG 600V THHN		25A	14.6A
FPHSR12A1C	14-4 AWG 600V THHN		25A	16A
FPHSR12A3D	14-4 AWG 600V THHN		15A	10.5A
FSHSR12B1C	14-4 AWG 600V THHN		25A	15.4
FPHSR18A3D	14-4 AWG 600V THHN		30A	20A
FSHSR18B3D	14-4 AWG 600V THHN		20A	14.5A
FPHSR24A3D	14-4 AWG 600V THHN		35A	22A
FSHSR24B3D	14-4 AWG 600V THHN		35A	21A
FSHSR36B3D	14-4 AWG 600V THHN		40A	25.8A

Table E.1

Attention:

La prise doit être accessible même une fois l'installation de l'appareil achevée, dans le cas où il serait nécessaire de le débrancher. Si cela n'est pas possible, reliez l'appareil à un commutateur muni d'une séparation de contact d'au moins 3 mm, situé dans un endroit accessible même après installation.

FRANÇAIS

Schéma de câblage

Assurez-vous que la couleur des fils de l'unité extérieure et du numéro de terminal est la même que celle de l'unité intérieure.

1) 208/230V

Terminal de
l'unité intérieure

Terminal de l'unité
extérieure

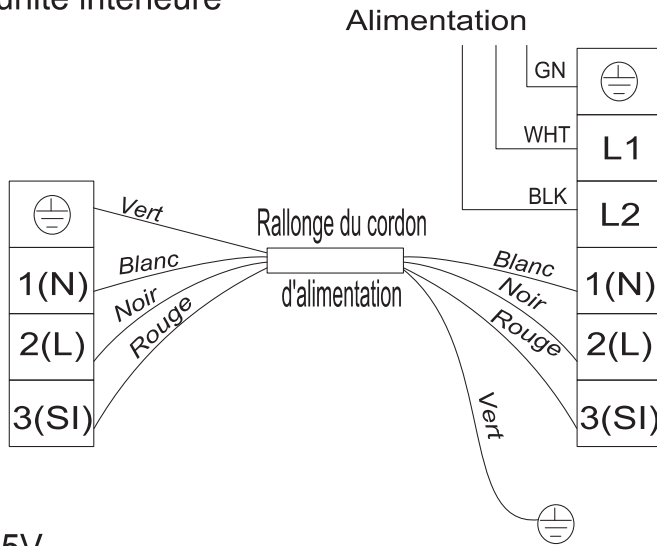

2) 115V

Terminal de l'unité
intérieure

Terminal de l'unité
intérieure

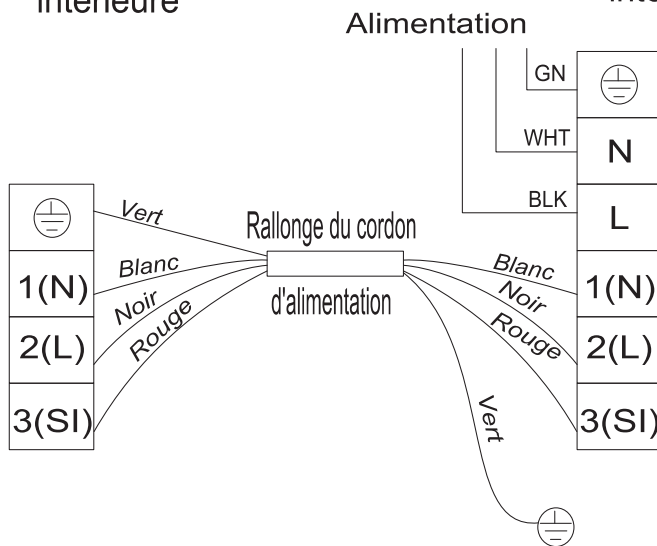

☑ Le diagramme est uniquement une référence, les bornes réelles du produit doivent être suivies.

Consignes d'installation

Charge et décharge

Le circuit est chargé en humidité et en eau, ce qui peut entraîner un dysfonctionnement du compresseur. Après avoir connecté les unités intérieures et extérieures, libérez l'air et l'humidité contenus dans le circuit de réfrigération au moyen d'une pompe à vide, comme cela est représenté ci-dessous.

Remarque : pour protéger l'environnement, pensez à ne pas décharger le liquide réfrigérant directement dans l'air qui vous entoure. Pour connaître les possibilités qui s'offrent à vous, consultez la page suivante.

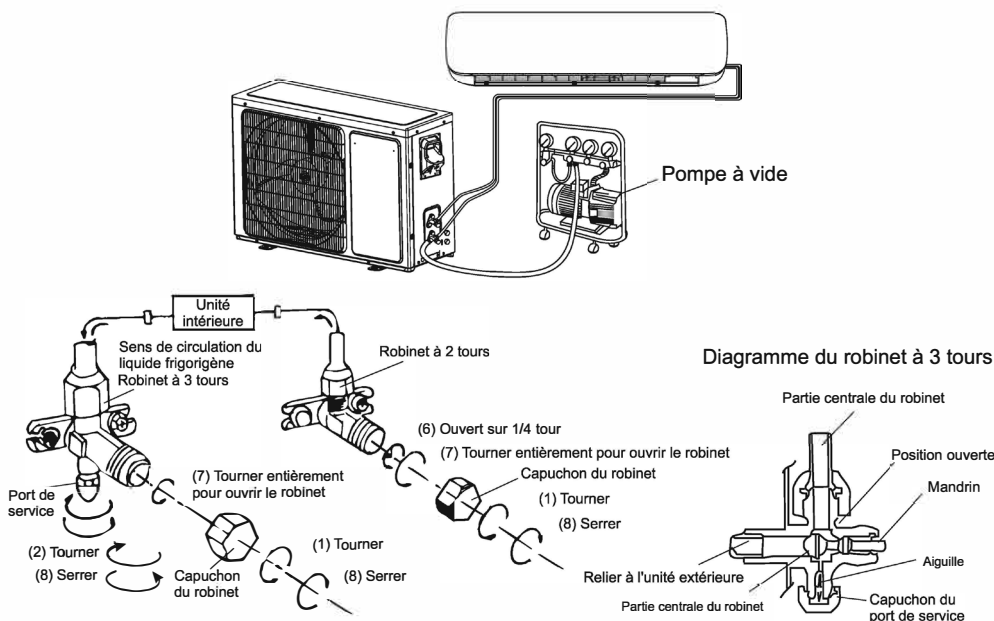

Comment vider les tubes à air :

- (1) Dévissez et retirez les capuchons des robinets à 2 et 3 tours.
- (2) Dévissez et retirez le capuchon du robinet de service.
- (3) Branchez le flexible du dispositif d'évacuation au robinet de service.
- (4) Démarrez la pompe à vide et faites-la tourner pendant 10-15 minutes jusqu'à ce que l'aspiration atteigne 10 mm Hg absolus.
- (5) Avec la pompe toujours en fonctionnement, fermez le bouton de pression basse situé sur le levier de la pompe. Arrêtez ensuite la pompe.
- (6) Ouvrez le robinet à 2 tours, puis refermez-le après 10 secondes. Vérifiez l'épaisseur de tous les joints au moyen de savon liquide ou d'un détecteur de fuites électronique.
- (7) Refermez bien les robinets à 2 et 3 tours. Débranchez le flexible de la pompe.
- (8) Remettez les capuchons des robinets en place et serrez-les bien.